

Strain Indicator and Recorder



FEATURES

- Four input channels
- Direct reading LCD display
- On-board data storage
- 0 to 2.5Vdc analog output
- Quarter, half and full bridge circuits
- Built-in bridge completion
- 120-, 350- and 1000-ohm dummy gages
- Automatic zero-balancing and calibration
- Remote shunt calibration of transducers
- Intuitive, menu-driven operations
- USB data link
- Portable, lightweight and rugged
- Battery, USB or line-voltage power

DESCRIPTION

The Model P3 Strain Indicator and Recorder is a portable, battery-operated instrument capable of simultaneously accepting four inputs from quarter-, half-, and full-bridge strain-gage circuits, including strain-gage-based transducers. Water-resistant grommets in the hinged cover allow the lid to be closed with leadwires attached. Designed for use in a wide variety of physical test and measurement applications, the P3 functions as bridge amplifier, static strain indicator, and digital data logger.

The Model P3 Strain Indicator and Recorder, utilizing a large LCD display for readout of setup information and acquired data, incorporates many unique operating features that make it the most advanced instrument of its kind. An extensive, easy-to-use menu-driven user interface operates through a front-panel keypad to readily configure the P3 to meet your particular measurement requirements. Selections include active input and output channels, bridge configuration, measurement units, bridge balance, calibration method, and recording options, among others.

Data, recorded at a user-selectable rate of up to 1 reading per channel per second, is stored on a removable

multimedia card and is transferred by USB to a host computer for subsequent storage, reduction and presentation with third-party software.

A highly stable measurement circuit, regulated bridge excitation supply, and precisely settable gage factor enable measurements of $\pm 0.1\%$ accuracy and 1 microstrain resolution. Bridge completion resistors of 120, 350 and 1000 ohms are built in for quarter-bridge operation. Also, input connections and switches are provided for remote shunt calibration of transducers and full-bridge circuits.

The P3 operates from an internal battery pack of two readily available D cells. Battery life depends upon mode of operation but ranges up to 600 hours of continuous use for a single channel. It can also be powered by connection to an external battery or power supply, a USB port on a PC or with an optional external line-voltage adapter.

Strain Indicator and Recorder

HARDWARE SPECIFICATIONS

All specifications nominal or typical at + 23°C unless noted.

Inputs:

Eccentric-lever-release terminal blocks accept up to four independent bridge inputs. Accommodates 16-28 AWG (1.3 to 0.35mm dia.)

Bridge Configurations:

Quarter-, half-, and full-bridge circuits. Internal bridge completion provided for 120Ω, 350Ω and 1000Ω quarter bridges, 60 to 2000Ω half or full bridge.

Display:

Full dot-matrix structure with 128 dots x 64 dots FSTN positive, gray transfective LCD with backlight. Display update is twice a second.

Data Conversion:

High-resolution sigma-delta converter. 60Hz or 50Hz noise rejection. User selectable.

Basic Range:

±31,000 microstrain (±1 microstrain resolution) at Gage Factor = 2.000.

Accuracy:

±0.1% of reading ±3 counts. (Normal mode operation at Gage Factor = 2.000)

Gage Factor Settings:

Range 0.500 to 9.900.

Balance:

Single key operation to initiate automatic software balance.

Bridge Excitation:

1.5Vdc nominal. Readings are fully ratiometric, and not degraded by variation in excitation voltage.

Communication Interface:

Universal Serial Bus with type B connector. Used for transferring stored data and firmware.

Data Storage:

Media: Removable Multimedia Card (16Mb supplied)
Data Recording Rate: 1 reading per second maximum

Calibration:

Shunt calibration across each dummy resistor to simulate 5000 microstrain (± 0.1%). Remote calibration supported via assessable switch contacts at input terminal block.

Analog Output:

BNC connector. 0 to 2.5V maximum output. Device impedance of 2000Ω or greater. 480Hz output update rate.

Power:

Internal battery pack using two "D" cells. Battery life up to 600 hours (single channel, normal mode.) Can also be powered from USB or by external battery or other power source of 6 to 15Vdc. AC adapter optional.

Operational Environment:

Temperature 0 to + 50°C. Humidity up to 90% RH, non-condensing.

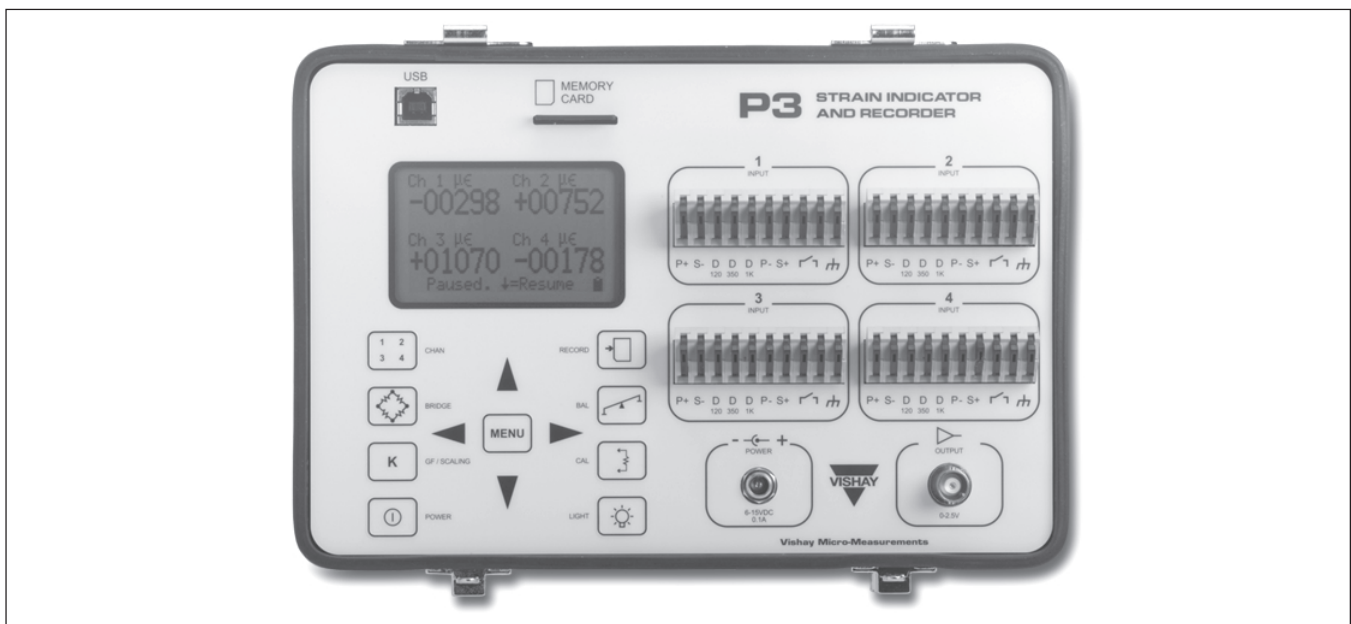



Strain Indicator and Recorder

FIRMWARE FEATURES**Display Update Rate:**

- 2 readings per second.

Recording Rates:

- Up to 64 data files.
- Automatic recording:
 - 1 reading every 1 to 3600 seconds.
 - individually selectable per channel.
- Manual Recording.
- Automatic date/time stamping.

Scaling:

- Automatic scaling for microstrain, based upon gage factor, with nonlinearity correction based upon bridge type.
- Automatic calculation of mV/V.
- Linear scaling for other engineering units.

Units:

- $\mu\epsilon$
- mV/V
- psi
- ksi
- GPa
- MPa
- Pa
- g
- lbf
- lb
- Kg
- in
- mm
- mil
- rpm
- m
- s
- A
- N
- V
- Ohms
- hp
- deg
- rad
- oz
- mV
- m/s²
- ton

Bridge Types:

- Quarter bridge.
- Half bridge, adjacent arms, equal and opposite strains.
- Half bridge opposite arms equal strains.
- Shear bridge, 2 active arms.
- Poisson half bridge.
- Full bridge 4 fully active arms.
- Shear bridge, 4 active arms.
- Full bridge, Poisson strains in opposite arms.
- Full bridge Poisson gages in adjacent arms.
- Undefined full bridge.
- Undefined half bridge/quarter bridge.

Bridge Balance:

- Automatic
- Manual offset adjust
- Disabled (Raw offset)

Backlight Control:

- Programmable on time while in run mode:
 - 5, 15 or 60 seconds.
 - Manual off/on.
- If illuminated, backlight will remain illuminated while operating menus.

Software Adjustable Contrast**Operating Modes:**

- Normal mode.
- Analog output (any one of four channels.)

Data Link:

- USB interface
- Windows-based P3 utility software provided for creating Excel and ASCII files from data stored on MMC.
- No device driver required (treated as a HID device).

Real-time Clock**System Calibration/Verification:**

- Requires Model 1550A Strain Indicator calibrator or other compatible calibrator.
- Calibration date stored in flash.

Firmware Upgradeable

INTERTECHNOLOGY
1-800-465-1600 INC.

1 Scarsdale Road
Don Mills, ON M3B 2R2

Tel: 416-445-5500
Fax: 416-445-1170

E-Mail: sales@intertechnology.ca
Website: www.intertechnology.com

Model P3 Strain Indicator And Recorder

Instruction Manual











Vishay Micro-Measurements
P.O. Box 27777 Raleigh, NC 27611 USA
Telephone: (919) 365-3800
Facsimile: (919) 365-3945
www.vishaymg.com
micro-measurements@vishay.com

TABLE OF CONTENTS

TABLE OF CONTENTS.....	I
1 DESCRIPTION.....	2
1.1 GENERAL.....	2
1.2 FUNCTIONAL FEATURES.....	3
2 SPECIFICATIONS.....	4
2.1 INPUT CONNECTIONS.....	4
2.2 BRIDGE CONFIGURATIONS.....	4
2.3 DISPLAY.....	4
2.4 DATA CONVERSION.....	4
2.5 MEASUREMENT RANGE/RESOLUTION.....	5
2.6 MEASUREMENT ACCURACY.....	5
2.7 GAGE FACTOR CONTROL.....	5
2.8 BALANCE CONTROL.....	5
2.9 BRIDGE EXCITATION.....	5
2.10 COMMUNICATION INTERFACE.....	5
2.11 DATA STORAGE.....	5
2.12 SHUNT CALIBRATION.....	5
2.13 ANALOG OUTPUT.....	6
2.14 POWER.....	6
2.15 OPERATIONAL ENVIRONMENT.....	6
2.16 CASE.....	6
2.17 SIZE & WEIGHT.....	7
3 FRONT PANEL.....	8
3.1 USB INTERFACE.....	8
3.2 MEMORY CARD SLOT.....	9
3.3 INPUT CONNECTORS.....	9
3.4 LCD DISPLAY.....	10
3.5 KEYPAD.....	10

3.6	POWER CONNECTOR	10
3.7	ANALOG OUTPUT CONNECTOR	10
4	OPERATION	11
4.1	GETTING STARTED	11
4.2	POWER UP	11
4.3	INPUT CONNECTIONS	12
4.3.1	Quarter Bridge Connections	12
4.3.2	Half Bridge Connections	13
4.3.3	Full Bridges and Transducers	13
4.4	OPERATIONAL MODES	14
4.4.1	Run Mode Operation	14
4.4.2	Command Mode Operation	18
4.5	MENU COMMANDS	19
4.5.1	Main Menu	19
4.5.2	Select Channels Menu	20
4.5.3	Bridge Type Menu	21
4.5.4	Gage Factor/Scaling Menu	24
4.5.5	Recording Menu	28
4.5.6	Balance Mode Menu	29
4.5.7	Shunt Calibration Menu	31
4.5.8	Options Menu	32
4.5.9	Display Options Menu	33
4.5.10	Output Options Menu	34
4.5.11	Save Setup Option	35
4.5.12	Clock Options	36
4.5.13	Advanced Options Menu	36
4.5.14	Calibrate System	36
4.5.15	Erase MMC	40
4.5.16	Poisson's Ratio	41
4.5.17	Factory Defaults	42
4.5.18	Version	42
5	BATTERY REPLACEMENT	43

6	SOFTWARE OPERATION.....	44
6.1	OVERVIEW	44
6.2	 SELECT CHANNELS.....	46
6.3	 BRIDGE TYPE	47
6.4	 GAGE FACTOR/SCALING	48
6.5	 POWER.....	49
6.6	 MENU	50
6.7	 RECORD.....	51
6.8	 BALANCE	54
6.9	 CALIBRATE	56
6.10	 BACKLIGHT	57
6.11	LOADING/SAVING SETUP INFORMATION	58
6.12	TRANSFERRING DATA	59
6.13	UPGRADING FIRMWARE	61



Model P3 Strain Indicator and Recorder

1 DESCRIPTION

1.1 GENERAL

The Model P3 Strain Indicator and Recorder is a portable, battery powered precision instrument for use with resistive strain gages and strain-gage-based transducers.

The Model P3 accepts full- half- and quarter-bridge inputs; all required bridge completion components for 120-, 350-, and 1000-ohm bridges are supplied. The Model P3 utilizes tool-free input connections, and is dust and moisture-resistant.

Operation of the Model P3 is straightforward and intuitive, using menu-driven commands, and can be controlled by either the front panel keypad or remotely via a USB connection.

The Model P3 utilizes modern digital signal processing technology to provide excellent noise rejection and stability. Proprietary scaling and linearization algorithms provide unsurpassed measurement accuracy for strain gage bridge measurements.

Data may be stored on industry-standard multimedia (MMC) cards or streamed to a PC using the on board USB interface.

1.2 FUNCTIONAL FEATURES

The Model P3 Strain Indicator and Recorder incorporates the following features:

- Four input channels.
- Direct-reading, backlit LCD display.
- Data storage using the multimedia card.
- Hardware and software support for quarter-, half- and full-bridge circuits.
- Built-in precision bridge completion for 120-, 350- and 1000-ohm half and quarter bridges.
- Automatic and manual zero-balance and calibration.
- Intuitive, menu-driven operations.
- Full control of all functions via USB Interface.
- Selectable analog output.
- Portable, lightweight and rugged design.
- Battery, USB, or line-voltage power.
- Intuitive, user-friendly software.

2 SPECIFICATIONS

Note: Performance may be degraded at high levels of repetitive electrostatic discharge; however, no damage to the unit will occur.

2.1 Input Connections

Type: Tool-free eccentric lever release

Quantity: Four

Wire size: 16 to 28 AWG [1.29 to 0.31mm Φ]

2.2 Bridge Configurations

Types: Quarter-, half-, and full bridges

Bridge Impedance: 60 to 2000 Ω

Internal Bridge Completion:

Quarter bridge: 120 Ω , 350 Ω and 1000 Ω \pm 0.01%

Half bridge: 1000 Ω \pm 0.01%

2.3 Display

Type: 128 x 64 pixel FSTN positive, gray transfective LCD with backlight

Update rate: 2 updates/second typ.

2.4 Data Conversion

A/D Converter: Delta-sigma with integral chopper-stabilized programmable gain instrumentation amplifier

Resolution: 24 bits. Noise-free resolution: 18 bits typ.

Output rate:

Normal mode: 50 or 60 samples/sec.

Analog output mode: 480 samples/sec.

Filter: Integrated linear phase FIR Sinc⁵ filter followed by a Sinc³ filter with a programmable decimation rate.

Software selectable output rate provides >120 dB rejection of 50 or 60Hz and higher level harmonics.

2.5 Measurement Range/Resolution

Strain Range: $\pm 31,000 \mu\epsilon$ at $GF = 2.000$. ($\pm 15.5 \text{ mV/V}$)

Resolution: $\pm 1 \mu\epsilon$ at $GF = 2.000$ ($\pm 0.0005 \text{ mV/V}$)

2.6 Measurement Accuracy

$\pm 0.1\%$ of reading ± 3 counts. (Analog output disabled, instrument Gage Factor = 2.000)

2.7 Gage Factor Control

Range: 0.500 to 9.900

2.8 Balance Control

Type: Software

Control: Manual or automatic

2.9 Bridge Excitation

Value: 1.5 VDC nominal

Control: Software enable/disable

Measurements are fully ratiometric, and not degraded by variations in excitation voltage

2.10 Communication Interface

Universal serial bus (USB). Cable included

2.11 Data Storage

Type: Removable Multimedia Card (supplied).

Recording rate: Software-selectable from 1 reading per second to 1 reading per hour

2.12 Shunt Calibration

Location: Across bridge completion resistors

Control: Software

Values:

P- to D120: $11.9\text{K}\Omega \pm 0.1\%$ ($5000\mu\epsilon$ at GF = 2.00)

P- to D350: $34.8\text{K}\Omega \pm 0.1\%$ ($5000\mu\epsilon$ at GF = 2.00)

P- to D1000: $99.5\text{K}\Omega \pm 0.1\%$ ($5000\mu\epsilon$ at GF = 2.00)

Remote calibration: Switch contacts at input terminal block

2.13 Analog Output

Value: 0 to 2.5V max

Ranges: $\pm 320\mu\epsilon$, $\pm 3200\mu\epsilon$, $\pm 32000\mu\epsilon$

Typical error: 0.5% of output voltage + 5mV

Maximum error: 1.4% of output voltage + 20mV

Update rate: 480 samples/sec

Output Load: 2000Ω

Connector: BNC

2.14 Power

Battery: Two Alkaline "D" cells

Battery life: 400 hours typ.

AC Adapter: 6-15VDC 100mA

USB: 5V 100mA

2.15 Operational Environment

Temperature: 0° to $+50^{\circ}\text{C}$

Humidity: Up to 90% RH. Non-condensing

2.16 Case

Material: Aluminum

Accessories: Two rubber grommets installed in the lid allow leadwires to enter the case with the lid closed for increased resistance to water splash

2.17 Size & Weight

Size: 9 x 6 x 6 in (228 x 152 x 152 mm)

Weight: 4.4 lb (2.0 kg), including batteries

3 FRONT PANEL

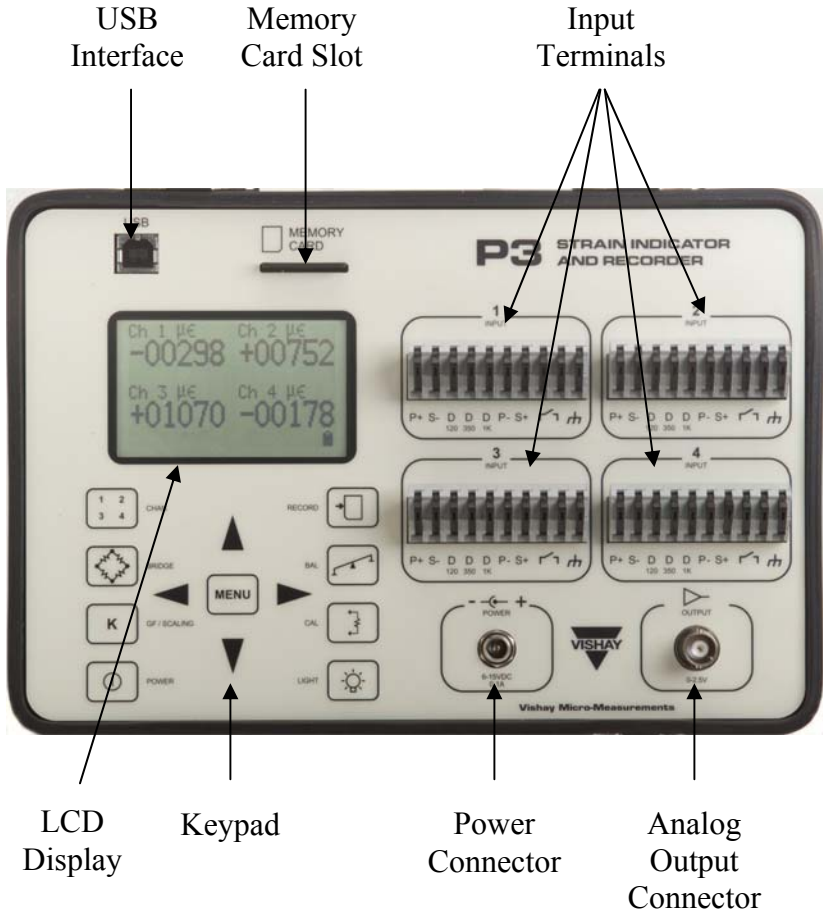

3.1 USB Interface

The USB interface is the communication channel between the P3 and a host PC. All front panel controls (except the system calibration option) are accessible via the USB interface.

When connected, the PC (running Windows 98, 2000, or XP) will identify the Model P3 as a standard USB Human Interface Device, therefore, no special device drivers are required to communicate with the device.

The Model P3 is supplied with user-friendly Windows-based application software which provides complete control of the Model P3.

In addition, an ActiveX control is supplied to simplify the development of user-defined applications.

The Model P3 can also operate as a stand-alone system, without being connected to the USB interface. In the stand alone configuration, all functions are controlled by the keypad.

3.2 Memory Card Slot

The memory card slot accommodates industry-standard multimedia (MMC) cards. Data can be recorded to the MMC by selecting the appropriate recording options. The multimedia card supports FAT16 or FAT12-formatted cards, such as the one supplied with the unit.

Recorded can be either uploaded to a PC using the on-board USB interface and the supplied software, or by using an industry standard Multimedia Card (MMC) reader.

3.3 Input Connectors

The input connectors connect the strain gage or transducer to the Model P3. To attach a wire to the input connector, simply lift the eccentric lever, insert the wire into the terminal opening, and lower the eccentric lever.

3.4 LCD Display

The LCD display provides the visual interface to control, setup, and monitor the P3.

3.5 Keypad

The keypad is a membrane-switch type. Functionality of the keys is described in the Operation section.

3.6 Power Connector

The power jack accepts a 6 to 15V DC source (0.1A max).

3.7 Analog Output Connector

The analog output jack provides a 0-2.5 volt output signal that corresponds to the displayed value. The output range is user-selectable.

4 OPERATION

4.1 Getting Started

The Model P3 is designed for ease of use. This section describes the operation of the Model P3 Strain Indicator and Recorder.

4.2 Power Up

The Model P3 is ready to use as received. The unit is shipped with two D cells pre-installed.

The Model P3 has three sources of power: Battery, USB or AC adaptor. If more than one power supply is present, the power source is determined in the following order: (1) USB, (2) AC Adaptor, and (3) battery. If the Model P3 is using USB or the AC adaptor, the system will always remain on as long as power is supplied. If the Model P3 is using the USB or AC adaptor as the power source, an "x" is displayed on the lower right corner of the LCD display, indicating the unit is running on external power. If the system is running on battery power, the 'x' is replaced by a battery strength indicator.

If no external supply is detected, the system must be turned on by pressing the Power key, .

When the unit is powered up, the firmware is loaded into the DSP. During this time an audible beep will be heard, indicating the unit is booting. After approximately two seconds, the beep tone will cease, unit will display the opening screen.

4.3 Input Connections

Strain gages and strain gage-based transducers are connected to the P3 through the input terminals. The P3 can accommodate up to four input channels, labeled 1 through 4. To connect the leadwire to the input terminal, lift the black arm of the desired terminal, insert the leadwire all the way into the terminal, and carefully lower the arm to clamp the wire to the terminal. Connections can be made whether the unit is on or off.

4.3.1 Quarter Bridge Connections

The following configuration illustrates the connections for making a three-wire quarter bridge connection:

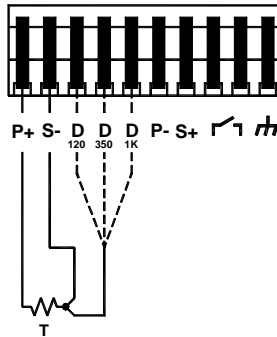

Select the dummy terminal (D₁₂₀, D₃₅₀, or D_{1K}) to correspond with the nominal resistance of the strain gage.

4.3.2 Half Bridge Connections

The following figure illustrates the connections for making a three-wire half-bridge connection.

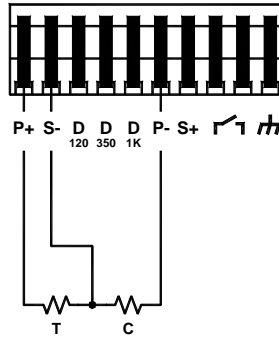

4.3.3 Full Bridges and Transducers

The following figure illustrates the connections for making a full-bridge connection:

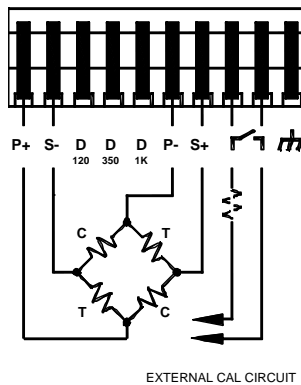

In addition to bridge wiring, a switch closure is provided for an external shunt calibration resistor. This feature will normally be used to implement shunt calibration of the transducer according to the transducer manufacturer's recommendation.

The transducer manufacturer will generally specify exactly how a specific value of shunt calibration resistor is to be connected. In some cases, the manufacturer may also supply leadwires, integral to the transducer assembly, which are used for this purpose. In any case, the transducer manufacturer's recommendations should be followed.

4.4 Operational Modes

The Model P3 has two operational modes: the run mode and the command mode.

4.4.1 Run Mode Operation

In the run mode, the display is divided into four quadrants (one for each channel), along with a status line on the bottom of the display.

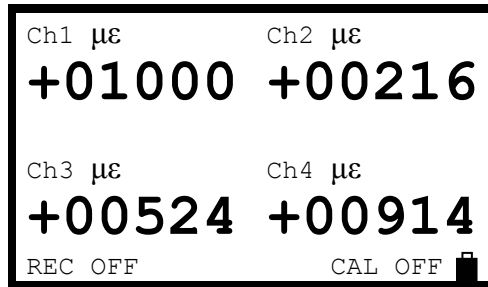

4.4.1.1 Display Pause

While in the run mode, the display can be paused (for example, to make a handwritten record of the current data). To pause the display, press the ◀ key.

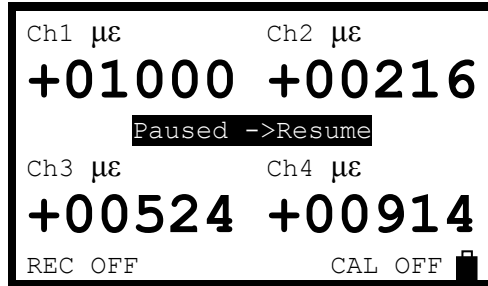

Note: While in the pause mode, recording to the MMC is also suspended. To resume to normal operation, press the ▶ key.

4.4.1.2 Peak Read

In addition, the Model P3 can be used as a peak hold indicator.

The peak hold function is accessed by using the ▲ and ▼ arrow keys.

Pressing the ▲ key will update the display if a value larger than the currently displayed value is measured.

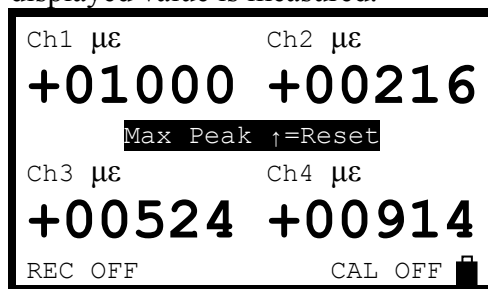

To reset the peak display, press the ▲. To return to the normal (tracking) mode, press .

Pressing the ▼ key will update the display if a value larger than the currently displayed value is measured.

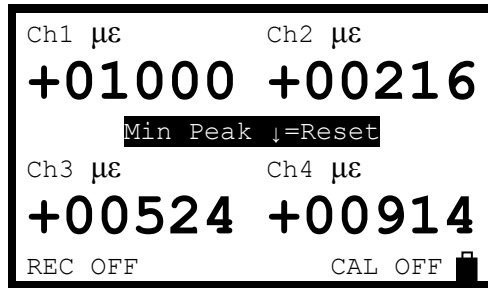

To reset the peak display, press the ▼ key. To return to the normal (tracking) mode, press .

4.4.1.3 Shunt Calibration

The shunt calibration switch may be toggled while in the run mode by pressing the cal  key. When activated, a precision shunt resistor is placed between the P- and the appropriate dummy (D_{xxx}) resistor, additionally, the Remote Cal switch closed. The internal shunt calibration resistors simulate an equivalent strain of 5000 microstrain at a gage factor of 2.000.





The lower right of the screen indicates whether the calibration switch is active (CAL ON) or inactive (CAL OFF).

4.4.1.4 Auto Balance

If any active channels are configured to use the auto balance mode, pressing the BAL  key will initiate the auto balance sequence. The auto balance sequence requires confirmation to avoid unintentional rebalance of the signal.

Ready to Auto Balance

[BAL] = Balance
[MENU] = Cancel

To start the auto-balance sequence, press the BAL  key. To cancel, press the  key. Once the balance sequence is completed, the user is given the option to save the settings to the flash memory. To save the settings, press the  key. In addition to saving the newly acquired balance readings, all setup information is saved (identical to the “Options|Save Setup” function). Press the  key to continue without saving the settings.

Save Settings?

[REC] = Save
[MENU] = Don't save

4.4.1.5 Manual Recording

If the recording mode is selected as "Manual" recording, pressing the Record  key will transfer the current readings to the Multimedia card.

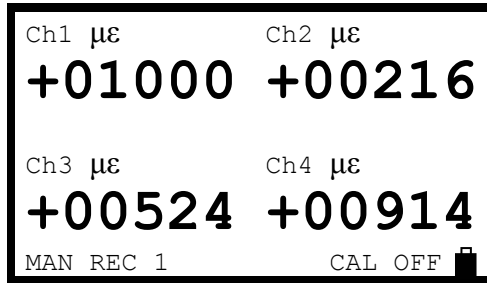







The total number of records in the currently open file will be indicated next to the MAN REC indicator on the bottom of the LCD.

4.4.1.6 Backlight

While in the run mode, pressing the Backlight  key will illuminate the backlight for the duration specified in the backlight options menu.

4.4.2 Command Mode Operation

The command mode is entered when the user is in the run mode and the , , , , key is pressed, or the  key is pressed when the record mode is off.

Pressing the Menu  key will display the Main Menu (see section 4.5.1).





Pressing the Select Channels  key will display the select channels menu (section 4.5.2).

Pressing the Bridge Type  key will display the Bridge Type Menu (section 4.5.3).

Pressing the Gage Factor/Scaling  key will display the Gage Factor/Scaling Menu (section 4.5.4).

4.5 Menu Commands

4.5.1 Main Menu

The Main menu is displayed when the  key is pressed while in the run mode. When the main menu appears, all measurement activity is suspended. Use the  and  arrow keys to highlight the desired menu item. Choose the desired item by pressing the  key.

```

** MAIN MENU **
Select Channels
  Bridge Type
  Gage Factor/Scaling
  Recording
  Balance
  Shunt Calibration
  Options

```

The following table briefly describes the menu items and the section of this manual associated with the item.

Menu Item	Section	Description
Select Channels	4.5.2	Displays the Select Channels Menu. This menu is used to enable/disable each channel
Bridge Type	4.5.3	Displays the Bridge Type Menu. This menu allows the user to select the type of bridge that is connected to each selected channel
Gage Factor / Scaling	4.5.4	Displays the Gage Factor/Scaling Menu
Recording	4.5.5	Displays the Recording Menu
Balance	4.5.6	Displays the Balance Menu
Shunt Calibration	4.5.7	Displays the Shunt Calibration Menu
Options	4.5.8	Displays the Options Menu

4.5.2 Select Channels Menu

The Select Channels menu is used to activate or deactivate each channel. If a channel is activated, the channel will accept inputs and the measured value will be displayed while in the run mode. A channel must be activated in order to be recorded, shunt calibrated, or balanced.

In order to activate/deactivate a channel, use the ▲ and ▼ keys to highlight the desired channel. Toggle the selection by using the ◀ and ▶ keys. Press the  key to return to the run mode.

```

* SELECT CHANNELS *
Chan 1: Active
Chan 2: Active
Chan 3: Active
Chan 4: Active

←→ Toggle   Menu=Exit

```

This menu can be directly accessed while in the run mode or the command mode by pressing the  key.

4.5.3 Bridge Type Menu

The Bridge Type menu selects the type of bridge connected to the selected channel. The bridge type menu is accessible from the main menu, or by pressing the  key. The bridge type determines whether the internal half bridge is used, and also determines the appropriate scaling/linearization algorithm based upon the bridge type selected.

```
* BRIDGE TYPE *
Ch 1: Undef HB/QB
Ch 2: Undef HB/QB
Ch 3: Undef HB/QB
Ch 4: Undef HB/QB

← Toggle      Menu=Exit
```

The table below summarizes the meaning of the provided bridge types. For more information on the calculations used by the Model P3, refer to the *Interactive Guide for Strain Measurement Technology*, available on the Vishay Micro-Measurements web site at <http://www.vishaymg.com>.

The following bridge configuration examples assume that the raw strain data is to be reduced to equivalent uniaxial strain with the nonlinearity correction applied where appropriate.

The "Undef" bridge, either HB/QB or FB, is selected when the net output of the active strain gages without mathematical cor-

rection for either Bridge configuration or nonlinearity applied is desired.

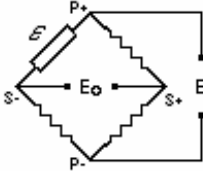
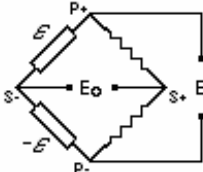
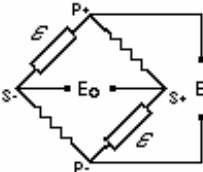
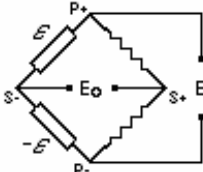
Display	Bridge Diagram	Description
Quarter		Single active gage in uniaxial tension or compression.
HB adj $\epsilon, -\epsilon$		Two active gages with equal and opposite strains -- typical of bending-beam arrangement.
HB opp $\epsilon, -\epsilon$		Two active gages with equal strains of the same sign -- used on opposite sides of column with low thermal gradient (bending cancellation, for instance.)
HB shear		Two active gages with equal and opposite strains aligned with the maximum and minimum principal strains to measure shear strain.

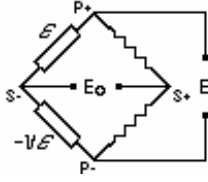
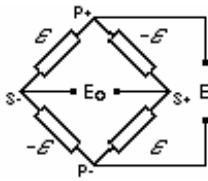
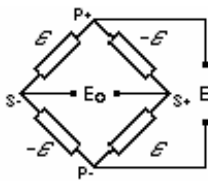
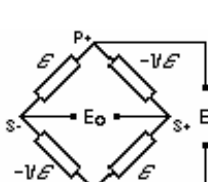
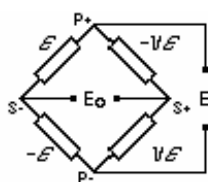
<p>HB adj $\epsilon, \nu \epsilon$</p>		<p>Two active gages in uniaxial stress field-- one aligned with maximum principal strain, the other with transverse "Poisson" strain. Default Poisson's Ratio = 0.3.</p>
<p>FB 4 active</p>		<p>Four active gages with pairs subjected to equal and opposite strains (beam in bending or shaft in torsion).</p>
<p>FB shear</p>		<p>Four active gages with pairs subjected to equal and opposite strains (beam in bending or shaft in torsion).</p>
<p>FB ν opp</p>		<p>Four active gages in uniaxial stress field-- two aligned with maximum principal strain, the other two with transverse "Poisson" strain (column). Default Poisson's Ratio = 0.3.</p>
<p>FB ν adj</p>		<p>Four active gages in uniaxial stress field - two aligned with maximum principal strain, the other two with transverse "Poisson" strain (beam). Default Poisson's Ratio = 0.3.</p>

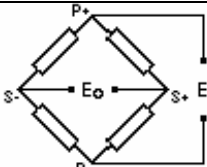
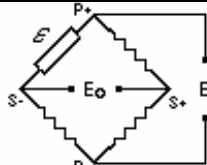
Undef FB		Undefined full bridge circuit. No correction for Wheatstone Bridge nonlinearity or active arms.
Undef HB/QB		Undefined half or quarter bridge circuit. No correction for Wheatstone Bridge nonlinearity or active arms.

4.5.4 Gage Factor/Scaling Menu

The Gage Factor/Scaling Menu allows the user to scale the input signal to display the measured data in the desired engineering units. The gage factor/scaling menu is accessible from the main menu or by pressing the **K** key. In order to highlight the desired item, use the **▲** and **▼** keys. Toggle the selection by using the **◀** and **▶** keys. Press the **MENU** key to return to the run mode.

Scaling options are determined by the units selected. To change the units, highlight the "Units" menu item and use the **◀** and **▶** keys to scroll through the provided units.

4.5.4.1 Microstrain Scaling

If the selected units are $\mu\epsilon$ (microstrain), scaling is determined by the gage factor of the sensor.

```
*GAGE FACTOR/SCALING*
Chan      : 1
Units     :  $\mu\epsilon$ 
Gage Factor : 2.000
```

To change the gage factor, highlight the "Gage Factor" menu item, and use the ◀ and ▶ keys to select the desired digit to modify. The digit is changed by using the ▲ and ▼ keys. The default gage factor is 2.000.

4.5.4.2 Millivolts per Volt Scaling

If the selected units are millivolts per volt (mV/V), no scaling is necessary, since the unit natively measures mV/V.

```
*GAGE FACTOR/SCALING*
Chan      : 1
Units     : mV/V
```

4.5.4.3 Other Engineering Units

For convenience, the following other engineering units are provided:

Psi	Pounds per square inch
Ksi	Thousand pounds per square inch
GPa	Gigapascals
MPa	Megapascals
Pa	Pascals
G	Grams or G's (acceleration)
Lbf	Pounds force
Lb	Pounds
Kg	Kilograms
In	Inches
Mm	Millimeters
Mil	Mils (1/1000 of an inch)
Rpm	Revolutions per minute
M	Meters
S	Seconds
A	Amps
N	Newtons
V	Volts
Ohm	Ohms
Hp	Horsepower
Deg	Degrees
Rad	Radians
Oz	Ounces
m/s ²	Meters per second ²
ton	Tons
degF	Degrees Fahrenheit
degC	Degrees Celsius

All of the above units assume linear scaling. In order to properly scale the data, it is necessary to supply the full scale value (in the selected engineering units) and the mV/V output at the full scale value.

```
*GAGE FACTOR/SCALING*
Chan      : 1
Units     : psi
Full Scale :      1
F.S. mV/V :  2.000
Dec. Places : Auto
```

To change the full scale value, use the ◀ and ▶ keys to select the desired digit to modify. The digit is changed by using the ▲ and ▼ keys. The default full scale value is 1.

The full scale value must be an integral value between +99999 and -99999. A full scale value of 0 is not permitted. The default value is 1.

The full scale mV/V value must be between +15.625 mV/V and -15.625 mV/V. A value of 0 is not permitted. The default value is 2.000.

Note that during manual calibration, the full scale value is fixed, and the full scale mV/V output is changed. It is therefore recommended to set this value at or near the expected full scale value when manually scaling the channel.

To change the number of decimal places being displayed, highlight the "Dec. places" menu item and use the ◀ and ▶ keys to change the value. The range of decimal places is 0-3.

4.5.5 Recording Menu

The recording menu selects the recording mode and the rate at which data is recorded to the multimedia card (MMC). The recording interval menu can be accessed directly from the main menu by pressing the  key.

There are three recording modes: Disabled, Auto, and Manual. Use the ▲ and ▼ keys to highlight the desired menu item. Toggle the selection by using the ◀ and ▶ keys.

4.5.5.1 Recording Disabled

In the disabled mode, recording will not occur.



4.5.5.2 Manual Recording

In the Manual recording mode, selected channels are recorded whenever the  key is pressed.

```
* RECORDING *
Mode : Manual
Chan 1 : ON
Chan 2 : OFF
Chan 3 : OFF
Chan 4 : OFF
← Toggle Menu=Exit
```

4.5.5.3 Auto Recording

In the Auto recording mode, selected channels are recorded at the specified interval. Each channel can be recorded from once per second to once per hour (3600 seconds). When in the Auto record mode, recording will begin when the  key is pressed

```
* RECORDING *
Mode : Auto
Chan 1 : 1 sec
Chan 2 : OFF
Chan 3 : OFF
Chan 4 : OFF
← Toggle Menu=Exit
```

4.5.6 Balance Mode Menu

The Balance Mode menu selects the balance mode for each channel.



Use the ▲ and ▼ keys to select the desired menu item. Change the highlighted selection by using the ◀ and ▶ keys. There are three modes: Auto, Manual, and Disable.

4.5.6.1 Auto Balance

Channels using the auto balance mode will automatically be balanced when the  key is pressed while in the run mode. The P3 makes a series of measurements and uses the mean value as the balance value.

```
* BALANCE MODE *  
Chan: 1  
Mode: Auto  
  
← Toggle Menu=Exit
```

4.5.6.2 Manual Balance

The manual balance mode allows the user to manually adjust the balance. This mode allows the user to introduce an offset in the reading. To adjust the offset, highlight the Adjust  Menu item and use the  and  keys to increase or decrease the measured value.

```
* BALANCE MODE *  
Chan: 1  
Mode: Manual  
Adjust ←  
  
+00010  
← Toggle Menu=Exit
```

4.5.6.3 Disable Balance

This mode disables the balance function. Channels using this mode have no correction for balance; however the initial amplifier zero is removed. This mode allows the user to evaluate initial bridge offsets.

```
* BALANCE MODE *
Chan: 1
Mode: Disable

↔ Toggle Menu=Exit
```

4.5.7 Shunt Calibration Menu

The Shunt Calibration menu allows the user to adjust the sensitivity of the selected channel (gage factor or full scale value) while a calibration signal is applied. In this menu, the shunt cal switch is closed. Use the ◀ and ▶ keys to select the desired channel to shunt calibrate. To adjust the calibration, use the ▲ and ▼ keys to highlight the Adjust ↔ menu item. Once selected, the ◀ and ▶ keys can be used to increase/decrease the sensitivity.

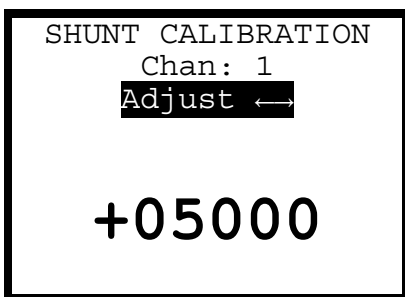

4.5.8 Options Menu

The Options Menu provides the ability to modify settings not directly related to making measurements. Use the ▲ and ▼ arrow keys to highlight the desired menu item. Choose the desired item by pressing the  key.

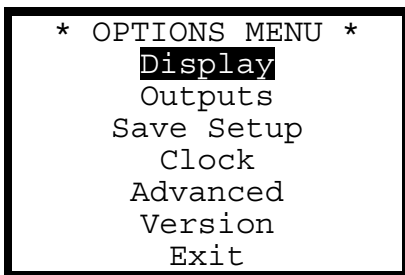

The following options are available:

Menu Item	Section	Description
Display	4.5.9	Adjusts the backlight and contrast settings
Outputs	4.5.10	Controls the analog output mode
Save Setup	4.5.11	Saves the current setup to the Flash memory
Clock	4.5.12	Adjusts the data/time of the real time clock
Advanced	4.5.13	Advanced options
Version	4.5.18	Displays the firmware version of the Model P3
Exit		Returns to the Run Mode

4.5.9 Display Options Menu

The Display Options menu allows the user to modify the LCD display parameters. Use the ▲ and ▼ keys to select the desired item. Change the selection by using the ◀ and ▶ keys.

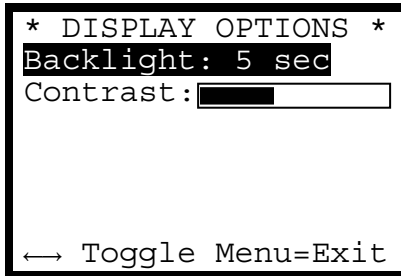

4.5.9.1 Backlight

Adjusts the duration of the backlight while in the run mode. The backlight key  activates the backlight. Valid options are:

5 sec	The backlight remains illuminated for approximately 5 seconds.
15 sec	The backlight remains illuminated for approximately 15 seconds.
60 sec	The backlight remains illuminated for approximately 60 seconds.
Toggle	The backlight remains illuminated until the Backlight key is pressed again.

Note: If the backlight is illuminated while the  key is pressed, the backlight will remain illuminated until the P3 returns to the run mode.

4.5.9.2 Contrast

The contrast control adjusts the contrast of the LCD display. Temperature variations may make it necessary to adjust the contrast of the LCD for the best viewing experience. Change the selection by using the ◀ and ▶ keys. A bar graph indicates the amount of contrast.

4.5.10 Output Options Menu

The Output Options menu chooses the operational mode. The possible modes are Normal, Analog out 1, Analog out 2, Analog out 3, or Analog out 4:

```

* OUTPUT OPTIONS *
Excitation: ON
Analog Out: Off
Rejection : 60Hz

↔ Toggle Menu=Exit

```

4.5.10.1 Excitation

ON: Bridge Excitation is applied during the measurement.

OFF: Bridge excitation is not applied during the measurement. This provides the ability to identify self-generating noise sources.

4.5.10.2 Analog Out

OFF: Data is collected at 0.5 second intervals. From one to 4 channels can be displayed. This mode provides the longest battery life, since excitation is on only during the A/D conversion.

Ch1 – Ch4: Data is collected at approximately 2ms intervals (480 samples/sec) and the reduced data is available to the analog output connector. This mode significantly decreases battery life, since the A/D converter and excitation is constantly on. Only one channel can be active at a time.

4.5.10.3 Rejection

The digital filters in the Model P3 can be tuned to optimize the noise rejection from power line frequencies. Choose between 50Hz and 60Hz

4.5.10.4 Out Range

The analog output range can be adjusted to provide full scale output range of ± 32000 (High), ± 3200 (Normal) or ± 320 (Low) microstrain at Gage Factor of 2.000. Note that while the output range can be adjusted, the resolution remains unchanged.

4.5.11 Save Setup Option

The Save Setup option takes the current instrument settings and stores them on the internal flash memory. When the system is powered on the next time, these settings will be utilized.

4.5.12 Clock Options

The Clock Options screen allows the user to set the date and time on the internal real-time clock. The clock is used to time stamp the recorded data. Highlight the desired field by using the ◀ and ▶ keys. The ▲ and ▼ keys change the value of the highlighted item.

```
* SET DATE/TIME *
MM/DD/YY  HH:MM:SS
10/17/02  16:47:43

↔ Change Field
↑↓ Change Value
Menu = Set
```

4.5.13 Advanced Options Menu

The Advanced Options menu allows the user to access less frequently used commands.

```
* ADVANCED OPTIONS *
Calibrate System
Erase MMC
Poisson Ratio: 0.30
Factory Defaults
Exit
```

4.5.14 Calibrate System

This option allows the user to recalibrate the Model P3. This process requires a Vishay Micro-Measurements Model 1550A Strain Indicator Calibrator, or another device with equivalent features and specifications.

```
* ADVANCED OPTIONS *
  Calibrate System
    Erase MMC
  Poisson Ratio: 0.30
  Factory Defaults
  Exit
```



System calibration is accomplished by making four measurements on each channel (amp zero, zero, positive and negative full scale). Once the measurements are made and the data validated, calibration values for amplifier zero and software gain are stored in the internal flash memory. Readings are validated by comparing the measured values with tolerances which are hard coded within the firmware. If the readings fall outside the established tolerances, the system will reject the calibration.

Once this menu item is chosen, the following screen is displayed:

```
SYSTEM CALIBRATION

Install calibrator
  On channel 1 now

  CAL = Calibrate
  MENU = Exit
```

Press the  key to begin the calibration process. To cancel the calibration operation, press the  key.

NOTE: Once the calibration process is initiated, it must be completed in full; otherwise, the system will lose its calibration information.

```
SYSTEM CALIBRATION

Set calibrator to
  0 microstrain

CAL = Calibrate
```

Connect the Model P3 to a Model 1550A Strain Indicator Calibrator, configured as a full bridge circuit, to channel 1. Set the 1550A to read 0 microstrain, positive polarity, and press the  key. The system will make a series of measurements, and evaluate the average readings. If the system determines that the values are not within a reasonable range an error screen will be displayed:

```
Zero measurement
Exceeds tolerance
Calibration aborted

Menu = Exit
```

The system will then revert back to the previous calibration values. If the readings are within tolerance, the system initiates the next step:

```
SYSTEM CALIBRATION

Set calibrator to
+30000 microstrain

CAL = Calibrate
```

Set the 1550A calibrator to read 30000 microstrain (positive polarity), and press the  key.

The system will make another series of measurements, validate the readings, and, if valid, will display the next step:

```
SYSTEM CALIBRATION

Set calibrator to
-30000 microstrain

CAL = Calibrate
```

Set the 1550A calibrator to -30000 (negative polarity), and press the  key.

Finally, the system needs to establish a true electrical zero (amp zero).

SYSTEM CALIBRATION

Set calibrator to
S+/S- short

CAL = Calibrate

Short the S+ and S- terminals on the 1550A calibrator and press the  key.

This process will repeat on the remaining three channels. Once the calibration process is complete, the system will store the new calibration coefficients in the internal flash memory, along with the calibration date.

NOTE: The model P3 is a ratiometric measuring device, so the measurement is not affected by fluctuations in the excitation voltage. It is therefore important to use a Wheatstone Bridge-based calibrator. Other sources, such as a precision voltage reference, are not suitable for calibration purposes.



4.5.15 Erase MMC

The Erase MMC option erases all files on the multimedia card.

```
* ADVANCED OPTIONS *
  Calibrate System
  Upgrade Firmware
  Erase MMC
Poisson Ratio: 0.30
  Factory Defaults
  Exit
```

To prevent accidental erasure, a confirmation screen is displayed:

```
Erase MMC?
REC=Yes  Menu=No
```

Press the  key to erase the card. Press the  key to abort without erasing.

4.5.16 Poisson's Ratio

This option allows the user to define Poisson's ratio of the material that the strain gage is bonded to. Poisson's ratio is used to calculate strain in bridge configurations which are dependent upon Poisson's ratio.

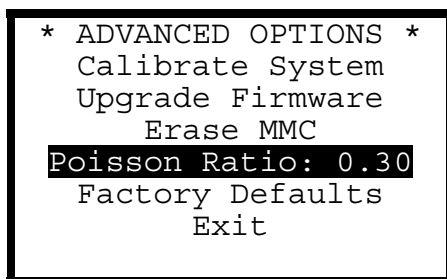

Use the ◀ and ▶ keys to increase or decrease this value. The factory default is 0.3.

4.5.17 Factory Defaults

This option returns the P3 to its initial factory settings. The settings can be made permanent by pressing the  record key when prompted.

4.5.18 Version

This option displays the splash screen and the version information. Normal operation resumes after approximately 3 seconds.

5 Battery Replacement

When the P3 is operated under battery power, battery condition is indicated by the battery icon, located on the lower right hand corner of the screen in the run mode.

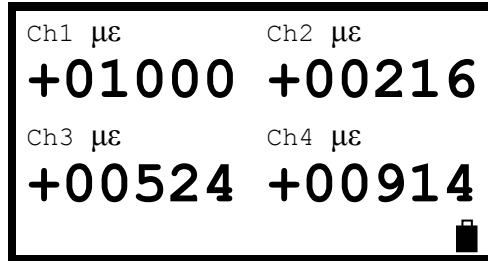

When the battery icon indicates that the battery is low (by replacing the battery icon with "LO" on the lower right corner of the display), the batteries should be changed. To replace the batteries, follow these steps:

1. Remove the four screws located on the bottom of the case with a Phillips head screwdriver and remove the instrument from the case.
2. Remove the two screws from the battery retainer plate using a Phillips head screwdriver.
3. Remove the two "D" cells from the retainer, and replace them with two new alkaline "D" cells. OBSERVE CORRECT POLARITY.
4. Reassemble the unit.
5. Reset the date/time (Options|Clock).

NOTE: If the P3 must remain on during battery replacement, connect a power source to either the Power In jack or the USB connector.

6 Software Operation

6.1 Overview

The Model P3 is supplied with an Application (P3.exe) which provides the ability to set up and collect data from the model P3 via the USB Interface. The Software is designed to operate in a similar manner as the Model P3.

To operate the software, connect the USB interface on the model P3 to an open USB port on the PC using the supplied cable. Once physically connected, start the application from Windows by navigating to the following menus:

Start->Programs->Vishay Micro-Measurements->Model P3->Model P3 Software

Once the program loads, an image of the Model P3 will be displayed.

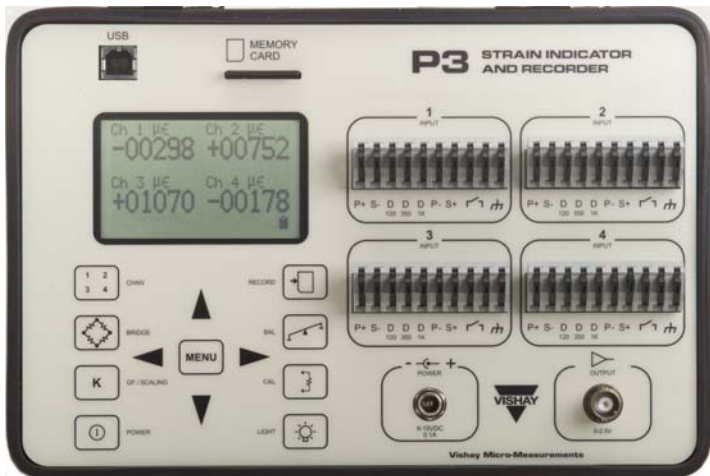

To access this document, right click anywhere on the P3 image and select "Help", or press the F1 key. To minimize the display, right click and select "Minimize".

Various functions are accessible by moving the mouse over the desired button and left clicking. Specific functions are described in the following sections.

6.2 Select Channels

The Select Channels button chooses which channels will be displayed and (optionally) recorded. Select the desired channels by clicking on the appropriate channel button. If the button is illuminated, the channel is selected.



Press OK to complete the selection, or Cancel to abort the operation.

6.3 Bridge Type

The Bridge Type Button chooses the type of bridge configuration and scaling is to be used. Choose the bridge type from the drop-down list of configurations. Possible configurations are described in section 4.5.3. Press the OK button to change the settings. Press Cancel to discard changes.

Bridge Types

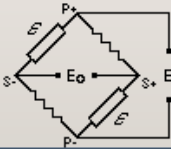
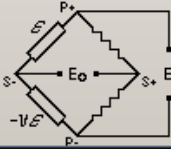
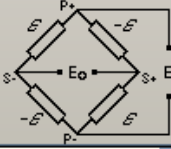
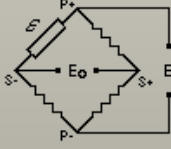
Ch 1	<div style="border: 1px solid gray; padding: 2px; margin-bottom: 5px;">Half Bridge - opposite arms - equal strains</div> <p>Two active gages with equal strains of the same sign -- used on opposite sides of column with low thermal gradient (bending cancellation, for instance.)</p>	
Ch 2	<div style="border: 1px solid gray; padding: 2px; margin-bottom: 5px;">Half Bridge - Poisson gage in adjacent arm</div> <p>Two active gages in uniaxial stress field -- one aligned with maximum principal strain, the other with transverse "Poisson" strain.</p>	
Ch 3	<div style="border: 1px solid gray; padding: 2px; margin-bottom: 5px;">Full Bridge - 4 fully active gages</div> <p>Four active gages with pairs subjected to equal and opposite strains (beam in bending or shaft in torsion).</p>	
Ch 4	<div style="border: 1px solid gray; padding: 2px; margin-bottom: 5px;">Quarter Bridge</div> <p>Single active gage in uniaxial tension or compression.</p>	

✓ OK
✗ Cancel

6.4 K Gage Factor/Scaling

The Gage Factor/Scaling dialog provides a means to select the scaling and labels shown on the P3 and the screen.

The screenshot shows a dialog box titled "Gage Factor/Scaling" with four sections, one for each channel. Each section contains the following fields:

- Channel 1 Label:** Ch 1 (text box)
- Units:** μe (dropdown menu)
- Gage Factor:** 2.000 (text box, range: 0.500 - 9.000)
- Full Scale Value:** 1 (text box, range: -99999 - 99999)
- Full Scale mV/V:** 2.000 (text box, range: -15.625 - 15.625)

Channels 2, 3, and 4 have identical settings to Channel 1. At the bottom of the dialog are two buttons: "OK" with a green checkmark and "Cancel" with a red X.

Choose the appropriate engineering units. The dialog dynamically changes the settable properties depending on the engineering units selected.

6.5 Power

Clicking on the Power button closes the Model P3 Application.

6.6 Menu

Clicking on the Menu Button displays the main menu on the PC, just as pressing the Menu button on the P3. To choose a menu item, simply move the mouse pointer over the item. When the item is highlighted, click the left mouse button. The list of menu items is the same as described in section 4.5, except for the following additional menu items available on the PC screen:

- Load/Save Settings
- Upload Data

6.7 Record

Clicking on the Record button chooses the desired recording options.

What type of recording do you want to perform ?

No recording

Manual recording

Time-based recording

Which channel(s) do you want to record?

Channel 1 Interval:

Channel 2 Interval:

Channel 3 Interval:

Channel 4 Interval:

Where do you want to record the data?

On the multimedia card on the P3

On this computer

Highlight the desired recording options, and click OK to begin recording.

If recording to the PC, a window will appear displaying the values in numeric or graphical format.

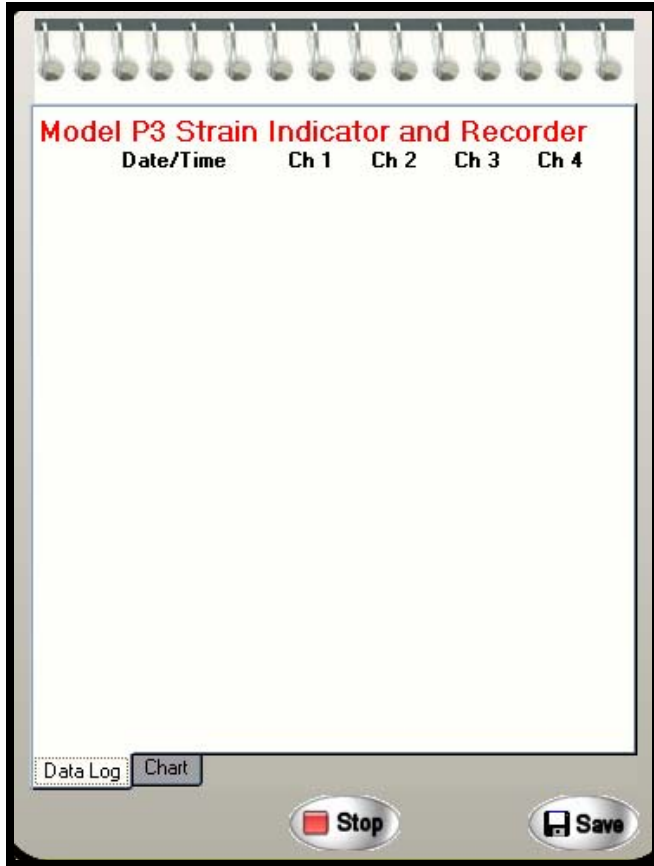

To stop recording, press the "Stop" button. To save the data to a file, press "Save". The data can be saved in the following formats: Rich text, ASCII, Excel, HTML, or XML.

If recording to the Multimedia card, the following dialog is displayed.



Press the "Rec" (Record) button to begin recording. Press the "Stop" button to stop recording.

6.8 Balance

The balance button provides the ability to change the balance mode of each channel and to adjust the balance manually or automatically.

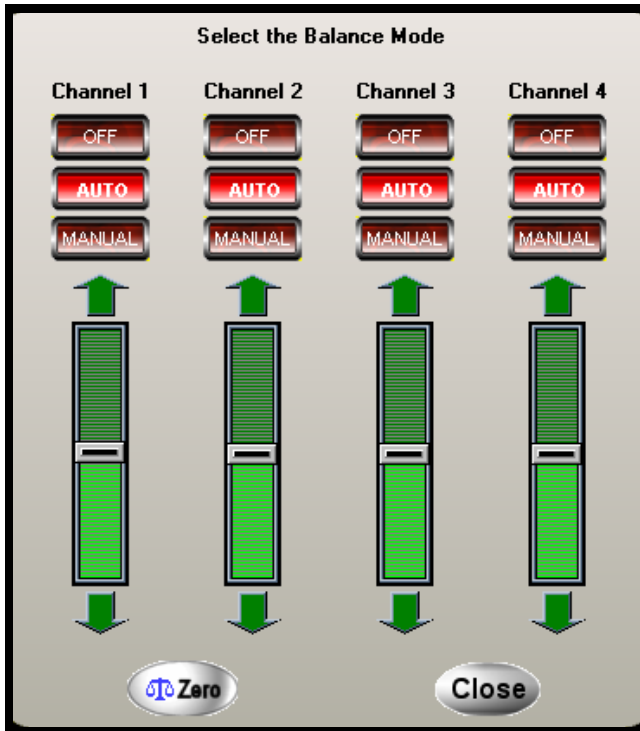

Choose the desired balance mode for each channel. If a channel is not selected, it will not be shown. To auto balance one or more channels, select the Auto balance option, and press the Zero button.

To Manually balance, select "manual", and adjust the slider to obtain the value near the desired reading. To make finer adjustments, press the up and down arrow buttons located above and below the corresponding slider control. The arrow buttons can be used in conjunction with the [Shift], [Alt], and [Ctrl] keys. Holding the [Alt] key while holding down the left mouse button over one of the arrow icons makes large changes, [Shift] changes more slowly, and [Ctrl] changes the most slowly.

6.9 Calibrate

Channel sensitivity can be set by clicking the calibrate button. To enable shunt calibration, press the CAL button. Use the slider control to make coarse adjustments to the sensitivity. Finer adjustments can be made by holding down the up and down arrows.

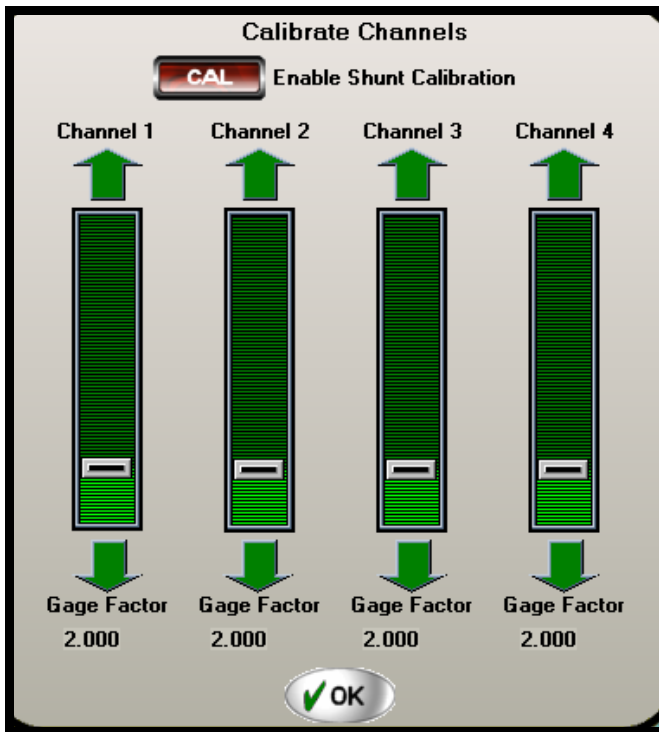

By holding the [Shift], [Ctrl], or [Alt] keys while holding the button down, one can achieve more or less sensitivity in the fine adjustment.

6.10 Backlight

The backlight button illuminates the simulated backlight on the PC screen and activates the backlight on the P3.

6.11 Loading/Saving Setup Information

System setup information, including balance and scaling information can be saved to the flash memory on the P3 or loaded and/or saved to the PC by choosing Load/Save setup from the Options menu.

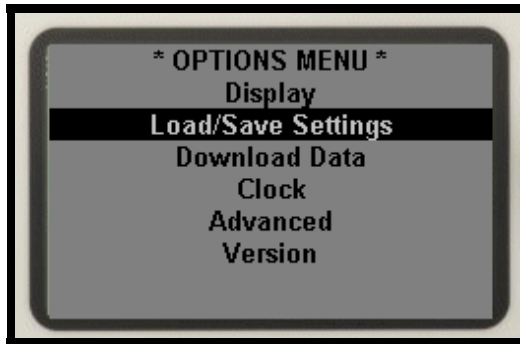

When selected, the following dialog appears:



Choose the desired option and press OK.

6.12 Transferring Data

Data stored on the Multimedia card may be downloaded via the USB interface by clicking on the Multimedia Card region on the screen or by selecting "Download Data" from the Options menu.

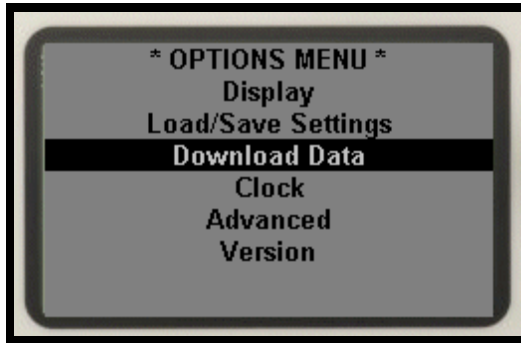

A list of files recorded to the MMC appears. To download a file, select the desired file and press the "Get" button. Once data is downloaded, a new tab sheet containing the downloaded data is displayed. This data can be saved to the PC by pressing the "Save" button. Data can be saved in ASCII, Rich Text, Excel, HTML, or XML formats.

Download File from Multimedia Card

File Name	File Created	Size (Bytes)
69323756.TXT	3/9/2005 10:49:46 AM	382

Files Data



6.13 Upgrading Firmware

To upgrade to a newer version of firmware, select "Upgrade Firmware" from the Advanced Options menu.

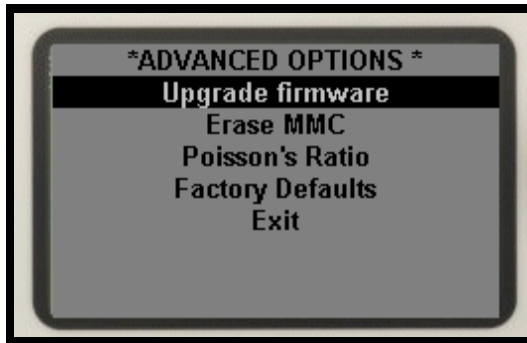

When selected, the following dialog appears:



Press "Open" to select the firmware to use. The version of the firmware will be displayed on the dialog. Press the Start button to begin the upgrade. Progress will be indicated on the progress

bar. If the upgrade fails, the system will revert to the previous firmware version. If successful, the new version of the firmware will execute the next time the system is powered up.

WARRANTY

Vishay Micro-Measurements, warrants all instruments it manufactures to be free from defect in materials and factory workmanship, and agrees to repair or replace any instrument that fails to perform as specified within three years after date of shipment. Coverage of computers, cameras, rechargeable batteries, and similar items, sold in conjunction with equipment manufactured by Vishay Micro-Measurements and bearing the identifying name of another company, is limited under this warranty to one year after the date of shipment. The warranty on nonrechargeable batteries and similar consumable items is limited to the delivery of goods free from defects in materials and factory workmanship. This warranty shall not apply to any instrument that has been:

- i) repaired, worked on or altered by persons unauthorized by the Vishay Micro-Measurements in such a manner as to injure, in our sole judgment, the performance, stability, or reliability of the instrument;
- ii) subjected to misuse, negligence, or accident; or
- iii) connected, installed, adjusted, or used otherwise than in accordance with the instructions furnished by us.

At no charge, we will repair, at our plant, or an authorized repair station, or at our option, replace any of our products found to be defective under this warranty.

This warranty is in lieu of any other warranties, expressed or implied, including any implied warranties of merchantability or fitness for a particular purpose. There are no warranties which extend beyond the description on the face hereof. Purchaser acknowledges that all goods purchased from Vishay Micro-Measurements are purchased as is, and buyer states that no salesman, agent, employee or other person has made any such representations or warranties or otherwise assumed for Vishay Micro-Measurements any liability in connection with the sale of any goods to the purchaser. Buyer hereby waives all rights buyer may have arising out of any breach of contract or breach of warranty on the part of Vishay Micro-Measurements, to any incidental or consequential damages, including but not limited to damages to property, damages for injury to the person, damages for loss of use, loss of time, loss of profits or income, or loss resulting from personal injury.

Some states do not allow the exclusion or limitation of incidental or consequential damages for consumer products, so the above limitations or exclusions may not apply to you.

The Purchaser agrees that the Purchaser is responsible for notifying any subsequent buyer of goods manufactured by Vishay Micro-Measurements of the warranty provisions, limitations, exclusions and disclaimers stated herein, prior to the time any such goods are purchased by such buyer, and the Purchaser hereby agrees to indemnify and hold Vishay Micro-Measurements harmless from any claim asserted against or liability imposed on Vishay Micro-Measurements occasioned by the failure of the Purchaser to so notify such buyer. This provision is not intended to afford subsequent purchasers any warranties or rights not expressly granted to such subsequent purchasers under the law.

Vishay Micro-Measurements reserves the right to make any changes in the design or construction of its instruments at any time, without incurring any obligation to make any change whatever in units previously delivered. Vishay Micro-Measurement's sole liabilities, and buyer's sole remedies, under this agreement shall be limited to the purchase price, or at our sole discretion, to the repair or replacement of any instrument that proves, upon examination, to be defective, when returned to our factory, transportation prepaid by the buyer, within the applicable period of time from the date of original shipment.

Return transportation charges of repaired or replacement instruments under warranty will be prepaid by Vishay Micro-Measurements.

Vishay Micro-Measurements is solely a manufacturer and assumes no responsibility of any form for the accuracy or adequacy of any test results, data, or conclusions which may result from the use of its equipment.

The manner in which the equipment is employed and the use to which the data and test results may be put are completely in the hands of the Purchaser. Vishay Micro-Measurements shall in no way be liable for damages consequential or incidental to defects in any of its products.

This warranty constitutes the full understanding between the manufacturer and buyer, and no terms, conditions, understanding, or agreement purporting to modify or vary the terms hereof shall be binding unless hereafter made in writing and signed by an authorized official of Vishay Micro-Measurements.