

INSTRUCTION MANUAL

Sound Level Meter

NL-42 / NL-52

 **RION CO., LTD.**

3-20-41 Higashimotomachi, Kokubunji, Tokyo 185-8533, Japan

<https://www.rion.co.jp/english/>



Organization of the NL-42/NL-52 documentation

Documentation for the Sound Level Meter NL-42/NL-52 comes in three parts, as listed below.

- **Instruction Manual (this document)**
Describes operating procedures for the NL-42/NL-52, connection and use of peripheral equipment such as a level recorder and printer, and use of the SD memory card.
- **Serial Interface Manual**
Describes communication with a computer, using the serial interface built into the NL-42/NL-52. The manual covers the communication protocol, use of control commands for the sound level meter, format of data output by the sound level meter, and other topics.
- **Technical Notes**
This document provides in-depth information about sound level meter performance, microphone construction and characteristics, influence of extension cables and windscreen on the measurement, and other topics.

The current instruction manual is available on our website.
(<https://www.rion.co.jp/english/>)

* Company names and product names mentioned in this manual are usually trademarks or registered trademarks of their respective owners.

Organization of this manual

This manual describes the features, operation and other aspects of the NL-42/NL-52. If the unit is used together with other equipment to configure a measurement system, consult the documentation of all other components as well. Pages v and following contain important information about safety. Be sure to read and observe these in full.

This manual contains the following sections.

Outline

Gives basic information about the unit.

Controls and Functions

Briefly identifies and explains the operation keys and connectors and all other parts of the unit.

Preparations

Explains how to check the unit before use and how to install and set up the unit for measurement.

Calibration

Explains how to calibrate the unit for measurement.

Reading the Display

Explains symbols and other information shown on the display of the unit.

Measurement

Explains the basic procedures for measurement.

Card capacity and store time

Lists the data store time corresponding to the SD memory card capacity, etc.

Store Operation

Explains how to store measurement data.

Input/Output Connectors

Explains the input and output connectors of the unit.

Default Settings

Lists the factory default settings of the unit.

Setup Files

Explains how to start up the unit using settings saved in a setup file.

Optional Accessories

Explains how to use the optional microphone extension cable, printer, and level recorder with the unit.

Specifications

Lists the technical specifications of the unit.

FOR SAFETY

In this manual, important safety instructions are specially marked as shown below. To prevent the risk of death or injury to persons and severe damage to the unit or peripheral equipment, make sure that all instructions are fully understood and observed.



Disregarding instructions printed here incurs the risk of death or severe injury to persons.

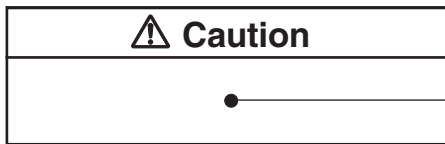

Disregarding instructions printed here incurs the risk of injury to persons and/or damage to peripheral equipment.



Disregarding instructions printed here incurs the risk of damage to the unit.

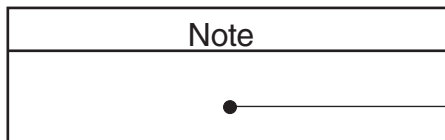

Additional information about using the unit. (These notes do not directly affect safety.)

Quantifier Notation

(Sound level and sound pressure level are expressed uniformly as sound pressure level, distinguished by the use of frequency weighting.)

	Measurement value	The time weighting characteristics	
		F, S	I
L_p Sound pressure level	A-weighted sound pressure level	L_{AF}, L_{AS}	L_{AI}
	C-weighted sound pressure level	L_{CF}, L_{CS}	(L_{CI})
	Z-weighted sound pressure level	L_{ZF}, L_{ZS}	(L_{ZI})
L_{eq} Equivalent continuous sound level	Equivalent continuous A-weighted sound level	L_{Aeq}	L_{AIeq}
	Equivalent continuous C-weighted sound level	L_{Ceq}	(L_{CIeq})
	Equivalent continuous Z-weighted sound level	L_{Zeq}	(L_{ZIeq})
L_E Sound exposure level	A-weighted sound exposure level	L_{AE}	(L_{AIE})
	C-weighted sound exposure level	L_{CE}	(L_{CIE})
	Z-weighted sound exposure level	L_{ZE}	(L_{ZIE})
L_{max}, L_{min} Maximum sound level	Maximum A-weighted sound level	L_{AFmax}, L_{ASmax}	L_{AImax}
	Maximum C-weighted sound level	L_{CFmax}, L_{CSmax}	(L_{CImax})
	Maximum Z-weighted sound level	L_{ZFmax}, L_{ZSmax}	(L_{ZImax})
L_N Percentile sound level	Percentile A-weighted sound level	L_{AFNn}, L_{ASNn}	(L_{AINn})
	Percentile C-weighted sound level	L_{CFNn}, L_{CSNn}	(L_{CINn})
	Percentile Z-weighted sound level	L_{ZFNn}, L_{ZSNn}	(L_{ZINn})
L_{peak} Peak sound level	A-weighted peak sound level	(L_{Apeak})	---
	C-weighted peak sound level	L_{Cpeak}	---
	Z-weighted peak sound level	L_{Zpeak}	---
L_{tm5} Takt-max sound level	Takt-max A-weighted sound level	L_{Atm5}	---
	Takt-max C-weighted sound level	(L_{Ctm5})	---
	Takt-max Z-weighted sound level	(L_{Ztm5})	---

- Z-weighted level is the same as an existing flat-weighted level.
- The combination of peak sound level and takt-max with I characteristics does not exist.
- Generally, measurement value shown in brackets () are not used or not suitable for evaluation.

Quantifier Notation of NL-42/NL-52 According to International Standards
and JIS

(Excerpts from ISO 1996, ISO 3891, IEC 61672-1, JIS Z 8202, JIS Z 8731)

NL-42/52 notation	Description	Frequency weighting	ISO notation	IEC notation	JIS notation			
L_Z	Sound level	Z	L_p	—	L_p			
L_A	A-weighted sound level	A	L_{pA}	—	L_{pA}			
L_C	C-weighted sound level	C	—	—	—			
L_{Zeq}	Equivalent continuous sound level	Z	—	—	—			
L_{Aeq}	Equivalent continuous A-weighted sound level	A	$L_{Aeq,T}$	$L_{Aeq,T}$	$L_{Aeq,T}$			
L_{Ceq}	Equivalent continuous C-weighted sound level	C	—	$L_{Ceq,T}$	—			
L_{ZE}	Sound exposure level	Z	—	—	—			
L_{AE}	A-weighted sound exposure level	A	L_{AE}	$L_{AE,T}$	L_{AE}			
L_{CE}	C-weighted sound exposure level	C	—	—	—			
L_{AN}	L_{A5}	Percentile A-weighted sound level	A	$L_{AN,T}$	$L_{A5,T}$	—	$L_{AN,T}$	$L_{A5,T}$
	L_{A10}				$L_{A10,T}$	—		$L_{A10,T}$
	L_{A50}				$L_{A50,T}$	—		$L_{A50,T}$
	L_{A90}				$L_{A90,T}$	—		$L_{A90,T}$
	L_{A95}				$L_{A95,T}$	—		$L_{A95,T}$
L_{Amax}	Maximum A-weighted sound level	A	—	—	—			
L_{Amin}	Minimum A-weighted sound level	A	—	—	—			
L_{Cpeak}	C-weighted peak sound level	C	—	L_{Cpeak}	—			

- Z-weighted level is the same as an existing flat-weighted level.

Precautions

- Operate the unit only as described in this manual.
- The NL-42/NL-52 is a precision instrument. Protect it from shocks and vibrations. Take special care not to touch the microphone diaphragm. The diaphragm is a very thin metal film which can easily be damaged.
- Use only the microphone/preamplifier assembly with the number as shown on the name plate of the unit.
- Do not use the preamplifier of this unit with sound level meters of other models. It may cause the preamplifier to fail.
- Ambient conditions for operation of the unit are as follows: temperature range -10°C to $+50^{\circ}\text{C}$, relative humidity 10% to 90% RH. Protect the unit from water, dust, extreme temperatures, humidity, and direct sunlight during storage. Also keep the unit away from air with high salt or sulphur content, gases, and stored chemicals during storage and use.
- If it starts raining while using the unit outside, stop the measurement and protect the unit from getting wet. In case the unit gets wet, wipe it with a dry cloth and let it dry in a well-ventilated place.
- The power cord used to connect the optional AC adapter to an AC outlet is a 100 V AC cord for domestic use in Japan, which is compliant with Japanese laws and electrical safety standards. Do not use this power cord outside Japan or with any voltage other than 100 V AC. Otherwise, RION cannot guarantee the safety of the equipment. Use a power cable that is compliant with the laws and electrical safety standards of your location.
- If you notice any sign of a problem during use, disconnect the AC adapter, remove the battery, and contact your supplier.
- Always turn the unit off after use. Remove the batteries from the unit if it is not to be used for a long time. Otherwise battery fluid may leak, posing a risk of corrosion and damage. Also disconnect the AC adapter or battery pack.
- When disconnecting cables, always grasp the plug and do not pull the cable.
- Before using the unit and before putting it away, always check that the microphone and microphone grid has not become loose. If this has happened, refasten the microphone grid firmly and then use or store the unit.
- Store this unit in the right place in the supplied storage case.

- Up to two units can be stored in the storage case. When storing the unit in an empty space, protect the unit by wrapping it with cushioning material. Note that we are not responsible for any failure or damage to the unit which occurs while the unit is stored in an empty space.
- Clean the unit only by wiping it with a soft, dry cloth or, when necessary, with a cloth lightly moistened with water. Do not use any solvents, cleaning alcohol or chemical cleaning agents.
- Do not try to disassemble or alter the unit. In case of an apparent malfunction, do not attempt any repairs. Note the condition of the unit clearly and contact the supplier.
- Do not tap the LCD panel or other surfaces of the unit with a pointed object such as a pencil, screwdriver, etc.
- Take care that no conductive objects such as wire, metal scraps, conductive plastics etc. can get into the unit.
- To ensure continued accuracy, have the unit checked and serviced at regular intervals. Contact the supplier.
- Dispose of the unit and of batteries only according to national and local regulations at the place of use.
- Do not remove the seal on the rear of the unit. If the seal is removed, the “water and dust resistant performance” of the unit is no longer guaranteed.
- In order to maintain the “water and dust resistant performance” of the unit, observe the following precautions.
 - Make sure that the battery compartment lid and bottom cover of the unit are firmly closed.
 - Do not open the battery compartment lid or bottom cover while the unit is wet.
 - Do not leave the unit in a wet state. Always wipe off any moisture and properly dry the unit.
 - Have the unit regularly checked and calibrated, to ensure continued “water and dust resistant performance”.
 - We recommend to have the packing inside the case and the bottom cover replaced regularly (fare-paying service). The recommended replacement cycle is five years. If more than two years have elapsed, the “water and dust resistant performance” of the unit will no longer be guaranteed. Regarding replacement of the packing and the bottom cover, please contact your supplier.

- The life of the backup battery for the internal clock of the unit is limited. You should have the battery replaced about once every five years. Regarding replacement of the battery, please contact your supplier.
- Please note that this product is warranted up to the product purchase price against defects in material.
- Never format optional program cards such as the NX-42EX and NX-42WR with SD memory card formatting software (such as SD Formatter, etc.). Otherwise the program data on the card will be erased and the respective functions can no longer be used. Restoration of the erased program is not warranted.

This product can be used in any areas including residential areas.

To conform to the EU requirement of the Directive on Waste Electrical and Electronic Equipment, the symbol mark on the right is shown on the instrument.



이 기기는 가정용(B급) 전자파적합기기로서 주로 가정에서 사용하는 것을 목적으로 하며, 모든 지역에서 사용할 수 있습니다.

Contents

FOR SAFETY.....	v
Outline.....	1
Controls and Functions.....	5
Front view.....	5
Bottom view.....	8
Rear view.....	9
Preparations.....	10
Power.....	10
Power on/off.....	14
Windscreen (WS-10, WS-15, WS-16).....	16
Diffuse sound field correction.....	17
SD memory card and program cards.....	18
Microphone extension cables (EC-04 series).....	19
Tripod mounting.....	21
Connection to a printer (DPU-414).....	22
Connection to a level recorder (LR-07, LR-20A) and data recorder (DA-20, DA-21, DA-40).....	24
Connection to a computer.....	25
Setting the date and time.....	26
Measurement in a dark location.....	27
Sub channel settings.....	29
Eco setting (Power-saving mode).....	32
Comparator output.....	33
Language selection.....	36
Calibration.....	37
Internal calibration (Electrical calibration).....	37
Acoustic calibration (with Sound Calibrator NC-75/NC-74 or Pistonphone NC-72B/NC-72A).....	39
Reading the Display.....	41
Measurement screen display.....	41
Sub channel display screen.....	46

Processed data display screen other than L_p value	46
Time-Level screen	47
Indicator messages.....	48
Menu list screen.....	49
System (Language).....	51
Display	54
I/O.....	57
Store.....	59
Measure.....	62
LN Mode.....	64
Save/Print.....	65
Option	66
Recall.....	67
WR.....	70
MENU list items	71
Measurement.....	72
Sound level (L_p) measurement.....	72
Equivalent continuous sound level (L_{eq}) measurement	74
Sound exposure level (L_{AE}), Maximum sound level (L_{max}), Minimum sound level (L_{min}) and Percentile sound level (L_N) measurement	79
Additional processing value measurement	80
Card capacity and store time	83
Using Auto store (when the NX-42EX is installed).....	83
When performing waveform recording (when the NX-42WR is installed)	84
Store Operation	85
Manual mode operation	88
Auto mode operation.....	92
Marker.....	95
Timer Auto mode operation	97
Data size information.....	102
About the store data format.....	102
About SD memory cards.....	102

Formatting an SD memory card.....	104
Screen hard copy	105
Input/Output Connectors	106
AC OUT connector	106
DC OUT connector.....	108
I/O connector.....	110
Default Settings.....	111
Setup Files	113
Resume function	113
Loading a start up file at startup	113
Restoring default settings (factory default settings)	114
Using setup files.....	115
Setting a start up file.....	118
Optional Accessories.....	119
Microphone extension cables (EC-04 series).....	119
Printer DPU-414	120
Level recorder LR-07/LR-20A	123
Program options	125
Specifications	126

Outline

The Sound Level Meter NL-42 and NL-52 are designed for sound level measurements according to the IEC standard. They support diffuse sound field measurements and also meets standard requirements when the supplied windscreen is mounted.

The NL-42 and NL-52 consist of the 1/2-inch electret condenser microphone UC-52 (for NL-42) and UC-59 (for NL-52), preamplifier NH-24 (for NL-42) and NH-25 (for NL-52), and the main unit. The preamplifier can be used by separating and extending from the main body. The unit is equipped with the operation keys and 3-inch backlit semitransparent color TFT LCD display to offer good visibility for indoor/outdoor use and also in a dark location.

The display supports various languages, and enables user-friendly, intuitive operation which can be operated comfortably by persons who are inexperienced in measurements.

The unit is equipped with AC OUT and DC OUT connector, I/O connector and USB connector as the output connectors.

Since the main unit offers the “water and dust resistant performance” equivalent to IP54 (except microphone unit), outdoor measurements can be performed without undue worries and a risk of failure caused by a sudden rain can be reduced.

The 113 dB wide linearity range enables measurement without switching ranges. Measurement results data are stored on the internal memory or inserted SD memory card of the unit.

The unit is designed for power saving, so operates continuously for up to 24 hours on four size AA batteries.

Also, in consideration of environment, nickel metal hydride rechargeable batteries can be used to help reduce the amount of battery waste.

Connecting to an external power is also possible. And the unit can be connected the external power supply for the long time measurement.

Communication with a computer is possible via the built-in I/O connector and USB connector. Because the USB connector conforms to storage specifications, the unit will be recognized as a removable disk when connected to a computer. This allows transfer of data from the SD memory card to the computer without having to remove the SD memory card from the unit.

The RS-232C interface allows sending measurement data to a printer.

Various optional programs allow users to add the following functions: long-time, continuous data recording to SD memory card, waveform recording, and comparator output. Also, various measurements are supported including octave and 1/3 octave band real-time analyses, FFT analysis, and additional measurements such as time weighting I (impulse).

In addition to the measurements of sound level, equivalent continuous sound level and maximum/minimum sound level, the unit can measure percentile sound level and sound exposure level. Up to 1000 measurement results can be stored in the main unit.

The NL-42/NL-52 allows the following quantity measurements.

Main processing

Simultaneous measurement of all items with selected time weighting (F, S) and frequency weighting (A, C, Z) characteristics

- Instantaneous sound pressure level L_p
- Equivalent continuous sound pressure level L_{eq}
- Sound exposure level L_E
- Maximum sound pressure level L_{max}
- Minimum sound pressure level L_{min}
- Percentile sound level $L_{N1}, L_{N2}, L_{N3}, L_{N4}$
(1 to 99, 1-increment steps)
 L_{N5} (0.1 to 99.9, 0.1-increment steps)

Additional processing

One of the following measurements can be selected for simultaneous processing with main processing.

- C-weighted equivalent continuous sound level L_{Ceq}
- C-weighted peak sound level L_{Cpeak}
- Z-weighted peak sound level L_{Zpeak}
- I-time-weighted equivalent continuous sound level L_{A1eq}
- Tact-max A-weighted sound level L_{Atm5}
- Maximum I-time-weighted equivalent continuous sound level L_{A1max}

(When the optional Extended Function Program NX-42EX is not installed, L_{A1eq} and L_{A1max} cannot be measured.)

The following options are available separately, to further enhance the range of applications for the product.

- Printer DPU 414
For producing hard copy of measurement data (including stored memory data).
- Level recorder LR-07
For recording sound level changes over time.
- Data management software for environmental measurement AS-60, AS-60RT
Total software of the environmental measurement for performing management of data.
- Waveform analysis software AS-70, CAT WAVE
For analyzing and saving of the WAVE format data file recorded by optional Waveform Recording Program NX-42WR.
- Extended Function Program NX-42EX
When NX-42EX is installed, a variety of programs can be added.
- Waveform Recording Program NX-42WR
For recording sounds. Recorded data can be played on computer and used for frequency analysis.

- Octave and 1/3 Octave Real-time Analysis Program NX-42RT
For performing octave band and 1/3 octave band real-time analysis.
- Reverberation Time Measurement Program NX-42RV
By adding this program, reverberation time measurement can be performed.
- FFT Analysis Program NX-42FT
For performing FFT analysis.

Once the optional Extended Function Program NX-42EX has been installed, it can no longer be uninstalled.

Controls and Functions

Front view

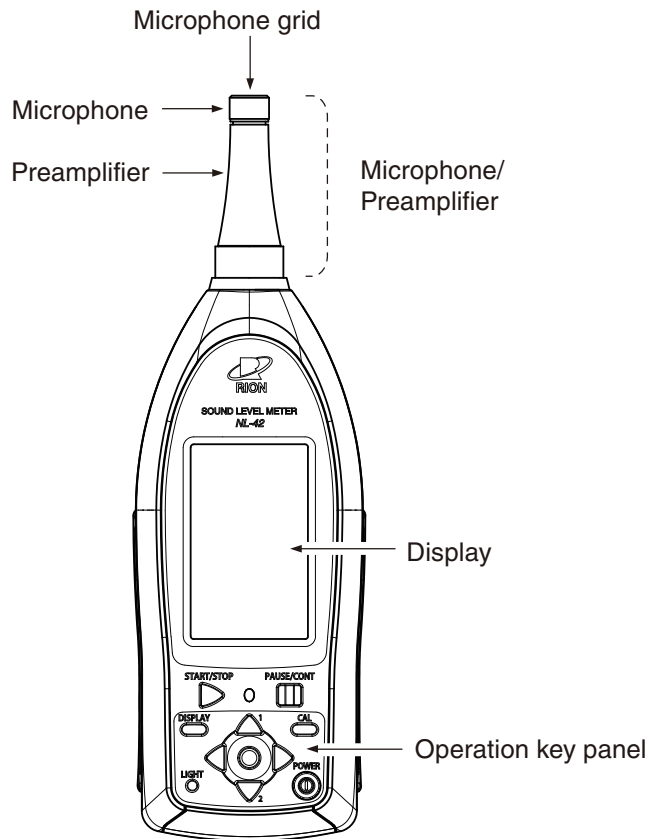

Microphone/Preamplifier

The microphone/preamplifier unit can be detached from the main unit and connected via an optional extension cable. This allows use at a separate location. Be sure to use only the microphone/preamplifier assembly with the number as shown on the name plate of the unit. Otherwise the product no longer conforms to specifications.

Before using the unit and before putting it away, always check that the microphone and microphone grid has not become loose. If this has happened, refasten the microphone grid firmly and then use or store the unit.

Display

The display of the unit is a backlit LCD panel. It shows the measured sound level as a numeric indication and as a bar graph. It also indicates the operation status of the unit and shows measurement parameters as well as warning indications and other information.

Operation key panel

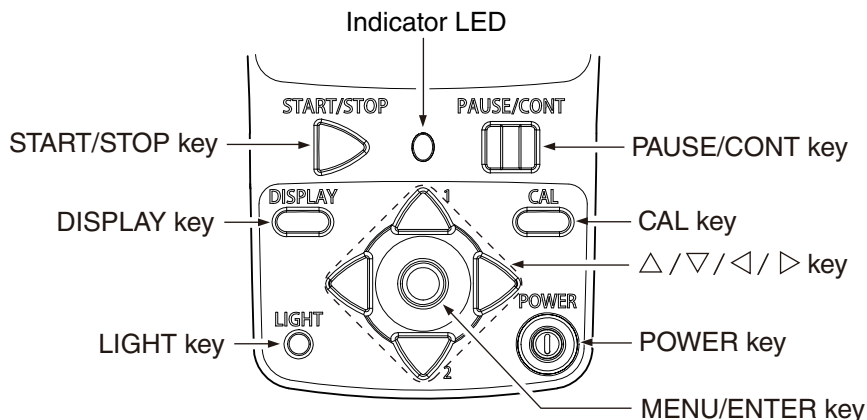

START/STOP key

Press to start or stop the measurement (including the various processing functions).

Indicator LED

Lights/flashes in red or blue to indicate the operation or status of the unit.

PAUSE/CONT key

During a measurement, this key can be used to exclude unwanted portions from processing. Press the key to pause measurement, and press the key again to resume measurement.

The back-erase function makes it possible to exclude data from an interval of several seconds (1, 3 or 5 second[s]) before the key was pressed from processing.

During pause in manual processing, the indicator LED flashes in blue.

Note

The PAUSE key does not function while the store mode is Auto or Timer Auto (when the optional NX-42EX is installed).

DISPLAY key

This key switches measurement screen display.

In addition, this key is used to bring up an explanation of the item on the screen by the help system.

MENU/ENTER key

Press this key to make or finalize the setting of an item in a menu or any other setting.

When the key is pressed at the measurement screen, the menu list screen comes up.

CAL key (Calibration key)

This key is used for calibration of the unit and for level calibration of connected equipment.

△/▽/◀/▶ keys

These four keys serve for selecting and setting items on menu screens.

LIGHT key

This key turns on the display backlight, for easier reading in a dark location. Press the key again to turn the backlight off.

When the automatic light out function was selected from the menu, the backlight will turn itself off automatically after the preset time.

Also press this key when you want to check the measurement settings in power-saving standby condition (see page 61).

POWER key

Turns power to the unit on and off. The key must be held down for at least 1 second to take effect.

Key lock

Pressing the ◀ and ▶ keys together activates the key lock. A lock symbol appears in the bottom left corner of the display, and the operation keys except for the LIGHT key are disabled.

If a key other than the LIGHT key is pressed, a key lock indication appears (see page 41).

Pressing the ◀ and ▶ keys together once more cancels the key lock.

To turn the unit off, you must first cancel the key lock and then hold down the POWER key.

The key lock does not function on the menu list screen and calibration screen.

Bottom view

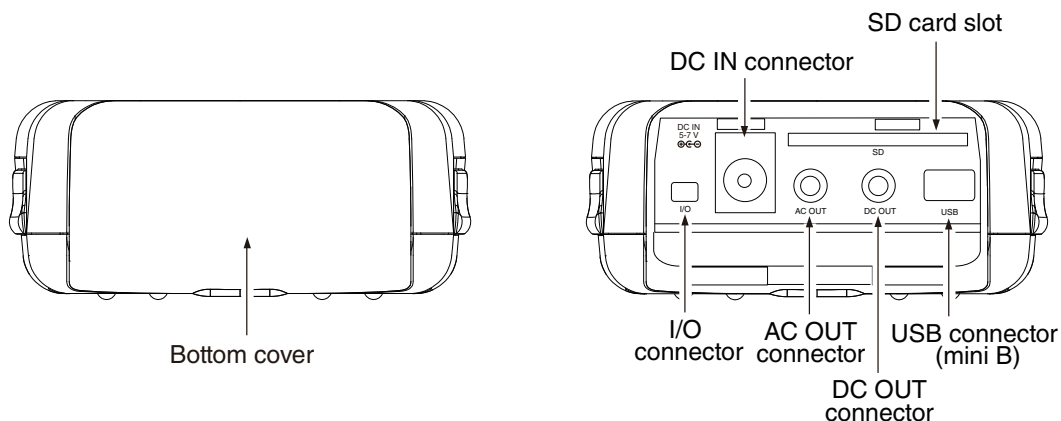

Bottom cover

This cover protects the connectors on the bottom during transport or storage. Removing the cover gives access to the connectors shown above.

Important

To keep the water and dust resistant performance, close tightly the bottom cover of the unit.

DC IN connector

The optional AC adapter NC-98 series can be connected here for powering the unit from an AC outlet (100 V to 240 V AC). The optional battery pack BP-21A can also be connected here.

Important

To prevent the risk of damage, do not use any AC adapter and battery pack other than the specified type.

SD card slot

The SD memory card can be inserted in this slot.

I/O connector

Serves for RS-232C connection (including printer) or a comparator signal is output here.

AC OUT connector

An AC signal corresponding to frequency weighting is output here.

DC OUT connector

A DC signal corresponding to sound pressure level is output here.

USB connector (mini B)

Serves for connection to a computer.

Rear view

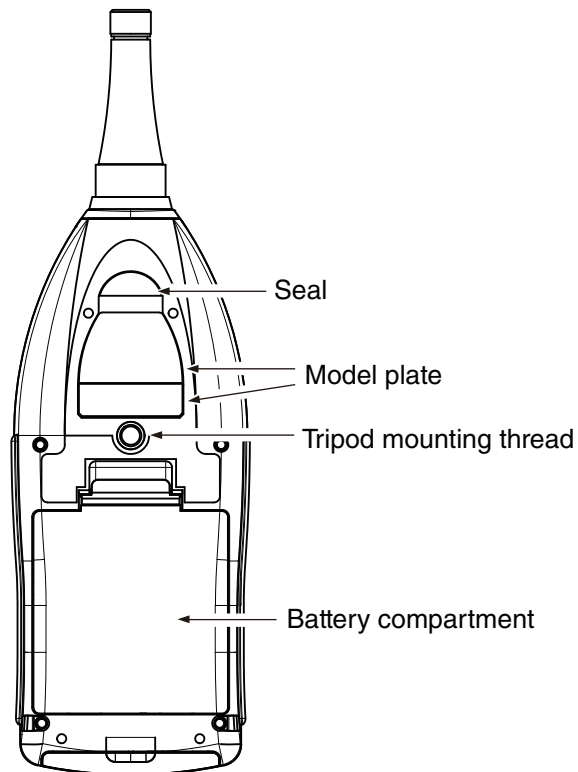

Seal

The seal guarantees the dustproof and waterproof performance of the unit.

Important

Note that the unit will not be covered by warranty against dustproof and waterproof performances if the seal is removed.

Model plate

Shows various information including model number of the unit, microphone number, preamplifier number, serial number, and date of manufacture.

Tripod mounting thread

The unit can be mounted on a camera tripod using this thread.

Battery compartment

Four batteries (IEC R6, size AA) are inserted here. The [power-on mode] switch is in the battery compartment. (see page 15)

Preparations

Power

The unit can be powered by four IEC R6, size AA batteries (alkaline), the optional AC adapter NC-98 series, and the optional battery pack BP-21A. Rechargeable nickel metal-hydrate batteries may also be used, but the unit does not have a facility for charging the batteries.

WARNING

If the unit is heated during use or the unit produces smoke or smell of burning, immediately remove the batteries from the unit or disconnect the AC adapter plug from the outlet, and then contact your supplier.

Note

When the AC adapter is connected, the unit will be powered from the adapter, also when batteries are inserted. (The AC adapter has priority.)

In case of a power failure or other interruption of AC power, the unit will automatically switch to battery power and continue operation.

When the unit is operated on external power only, the file auto close function and auto shutdown function will not be executed. We recommend that new batteries be set in the unit.

The unit responds to the momentary stop up to 50 ms.

Inserting the batteries

1. Remove the battery compartment lid as shown below.
2. Insert four IEC LR6, size AA batteries, paying attention to the polarity as indicated in the compartment.
3. Replace the cover.

Push the latch in the arrow direction and then lift up to open the lid.

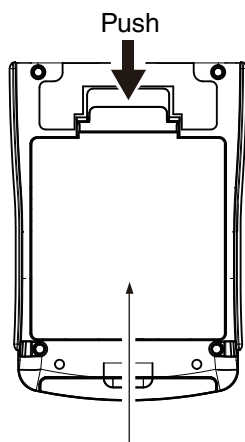

Battery compartment

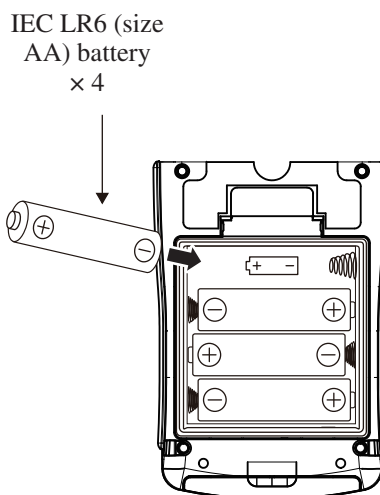

⚠ Caution

Take care not to reverse the (+) and (-) polarity when inserting the batteries. Incorrect setting of the batteries may cause battery explosion and leakage.

To prevent the risk of battery fluid leakage, remove the batteries from the unit when the unit is not used.

If the fluid from inside the battery sticks to your skin or clothing, wash it off immediately with clean water.

Important

Always replace all four batteries together. To prevent the risk of damage, do not mix old and new batteries or batteries of different type.

The life of a set of batteries depends on usage conditions and manufacturers. Some reference values are shown below.

Battery life (at 23°C)	Alkaline batteries	LR6	15 hours
	Nickel metal-hydrate batteries		15 hours

The life of a set of batteries is shown below when the NX-42EX is installed, Eco setting is ON, L_{eq} calculation interval is 10 min, and L_p store interval is OFF.

Battery life (at 23°C)	Alkaline batteries	LR6	26 hours
	Nickel metal-hydrate batteries		25 hours

The battery life shortens by 5% to 50% when the display backlight continuously ON (different according to the backlight brightness setting).

When either AC OUT or DC OUT is ON, battery life will be about 25% shorter (see pages 57 to 58).

When auto store is used, battery life will be 20% to 40% shorter.

Battery life may also be shorter when the program option is operating.

Important

The rechargeable nickel metal-hydrate battery is not charged by the NL-42/NL-52.
--

Note

The life of rechargeable nickel metal-hydrate battery depends on the battery type and charge condition.

In the factory default condition, AC OUT is set to “Inter lock” and DC OUT is set to “MAIN”. To extend the battery life, select [System (Language)] from the menu list screen and set [Eco Setting] (see page 32), or select [I/O] and set the both AC OUT and DC OUT to “OFF” (see pages 106 to 109).

AC adapter

To operate the unit with the AC adapter, connect it as shown below.

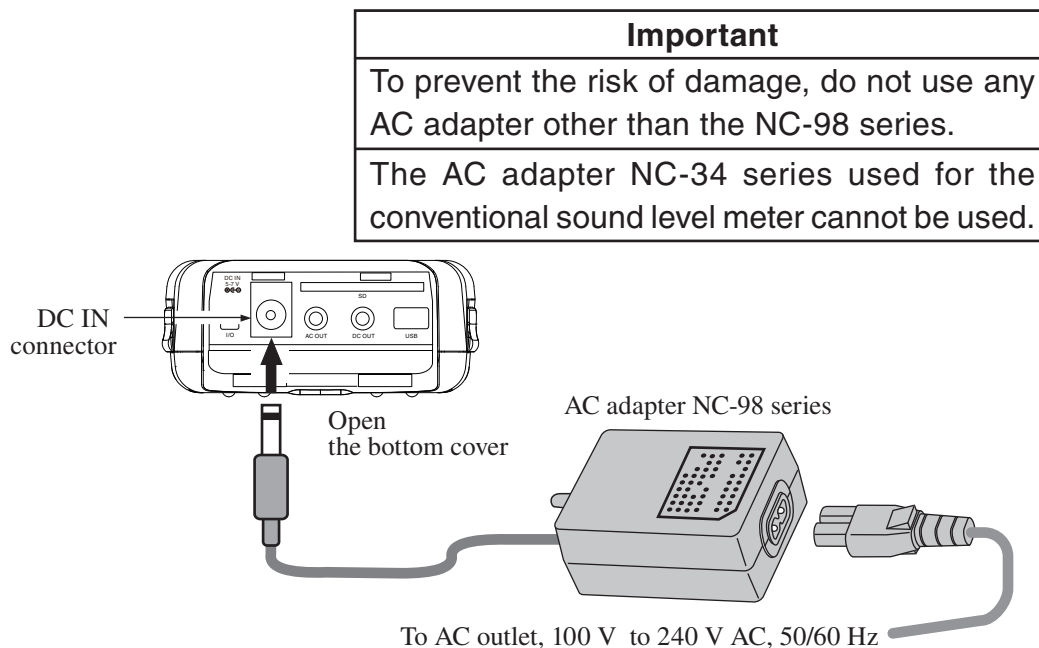

Backup battery

The unit uses a backup battery (rechargeable battery) to operate the clock.

While power to the unit is on, the backup battery will be charged. It will also be charged while power to the unit is off if external power is connected.

The relationship between charging time and retention period is shown below.

A full charge of the backup battery is achieved after 24 hours.

Charging time	Retention period
1 hour	2 days
12 hours	30 days
24 hours	45 days

Use the AC adapter when connecting external power for battery charge while the unit is turned off. The service life of the backup battery is limited. You should have the battery replaced about once every five years. Please contact your supplier.

Note
The charging time, retention period and service life of the backup battery may vary depending on the operating condition.
When the backup battery is old, the retention period will be shorter.

Power on/off

To turn the unit on

Hold down the POWER key until the power-on screen appears (at least 1 second). When the screen is shown, release the POWER key. After the unit has been started, the measurement screen appears.

During start up, the indicator LED flashes red → blue → red → ...

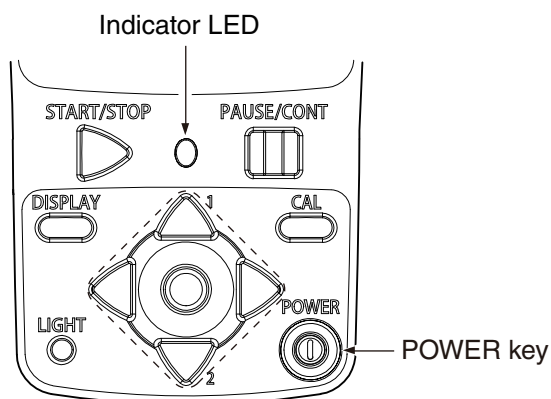

To turn the unit off

Hold down the POWER key until the unit is turned off (several seconds). When the power-off screen appears, release the POWER key.

Important

Remove the batteries from the unit if it is to be stored for a long time with the POWER key set to OFF to prevent possible damage caused by battery leakage, and disconnect the AC adapter or battery pack.

Note

After turning the unit off, wait at least 10 seconds before turning it on again.

If the key lock has been activated, pressing the POWER key has no effect. Press the ◁ key and ▷ key simultaneously to cancel the key lock condition, and then press the POWER key.

Power-on mode switch

Opening the battery compartment as shown below gives access to a switch labeled “A-B”. Normally the “A” position is used. Setting this switch to the “B” position allows the unit to be turned on simply by supplying power to the DC IN connector. In this case, the POWER key on the operation key panel of the unit has no effect.

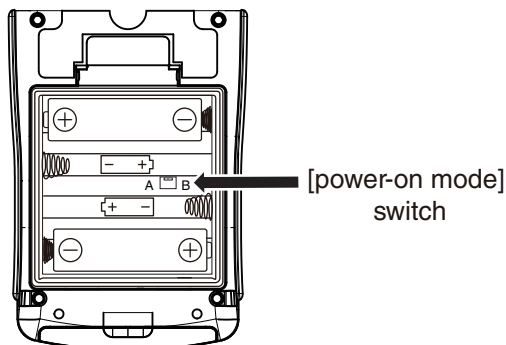

Important

When using the unit with the switch in the “B” position, do not insert batteries.

If the unit is turned off immediately after changing the setting while using the unit with the switch in the “B” position, the setting may not be resumed. After changing the setting, wait at least 10 seconds before turning the unit off.

Windscreen (WS-10, WS-15, WS-16)

When making outdoor measurements in windy weather or when measuring air conditioning equipment or similar, wind noise at the microphone can cause measurement errors. Such effects can be reduced by using the windscreen. Mounting the windscreen on the microphone will cause change in frequency response, as shown in the Technical Notes.

When using the windscreen, a windscreen correction can be executed according to the following procedure.

You can use the correction to ensure flat frequency response when the windscreen is mounted.

1. Press the MENU/ENTER key to bring up the menu list screen.
2. Use the $\Delta/\nabla/\triangleleft/\triangleright$ keys to select [Measure] and press the MENU/ENTER key. The measurement setting screen appears.
3. Use the Δ/∇ keys to select [Windscreen Correction] and press the MENU/ENTER key. The windscreen selection screen appears.
4. Use the Δ/∇ keys to select the model of windscreen and press the MENU/ENTER key.
5. Press the START/STOP key to return to the measurement screen.

Note

When using the All-Weather Windscreen WS-15, remove the windscreen fall prevention rubber.

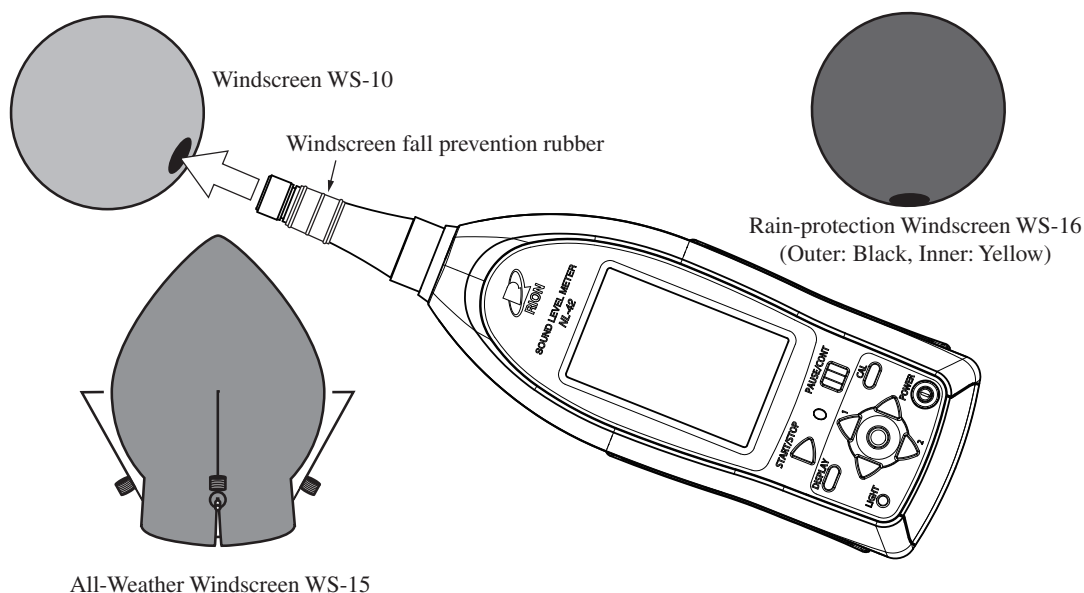

Diffuse sound field correction

When using the unit as an ANSI compliant device, set the diffuse field correction to ON.

This correction feature is designed to ensure flat frequency response in a diffuse sound field.

1. Press the MENU/ENTER key to bring up the menu list screen.
2. Use the $\Delta/\nabla/\triangleleft/\triangleright$ keys to select [Measure] and press the MENU/ENTER key. The measurement setting screen appears.
3. Use the Δ/∇ keys to select [Diffuse Sound Field Correction] and press the MENU/ENTER key. The ON/OFF setting screen appears.
4. Use the Δ/∇ keys to select [ON] and press the MENU/ENTER key.
5. Press the START/STOP key to return to the measurement screen.

SD memory card and program cards

Measurement data can be stored on an SD memory card for use and further processing in a computer. Optional program cards can also be used for installing software into the unit to expand the measurement functions of the unit.

Inserting a card

Important
Make sure that power is OFF before inserting or removing a card.
Take care to insert the SD memory card with correct orientation.
If the SD memory card is removed while data is being read or written to the card, the data may be destroyed.
Use SD memory cards provided by Rion. The performance of other cards is not guaranteed.
Note that we assume no responsibility for any damage or loss of stored measurement data.

1. Open the bottom cover of the unit.
2. Insert the SD memory card into the card slot on the bottom of the unit with the label of the card facing up. Push the card in until it is locked in place.
3. To remove the card, push the card a bit further in, the card is released and pops out of the card slot.

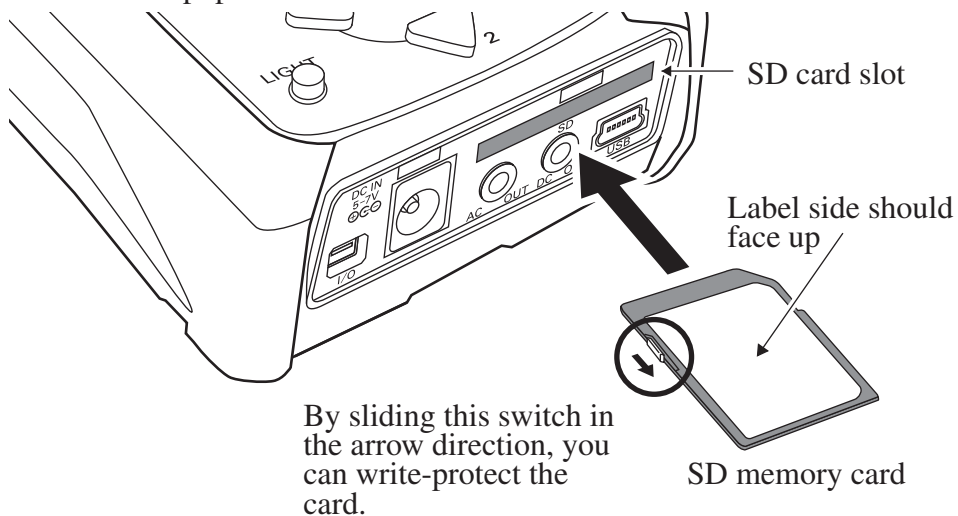

Microphone extension cables (EC-04 series)

Be sure to turn power to the unit OFF before separating the microphone from the main unit.

To reduce measurement deviations due to refraction effects and the acoustic influence of the operator, the microphone can be detached from the unit and connected via an extension cable. Available cables are listed in the table below. Combining multiple cables is also possible.

Type	Length
EC-04	2 m
EC-04A	5 m
EC-04B	10 m

Type	Length
EC-04C	30 m (reel) + 5 m (connection cable)
EC-04D	50 m (reel) + 5 m (connection cable)
EC-04E	100 m (reel) + 5 m (connection cable)

Important

With long extension cables, the cable capacitance restricts the upper measurement frequency and measurement level. For details, refer to the Technical Notes.

1. Loosen the preamplifier fastening screw and remove the preamplifier from the main unit.

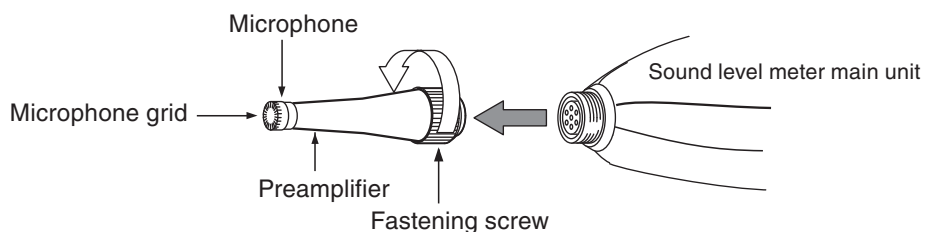

Important

Never separate the microphone and preamplifier, because this can lead to damage. Before using the unit and before putting it away, always check that the microphone and microphone grid has not become loose. If this has happened, refasten the microphone grid firmly and then use or store the unit. Never remove the microphone grid, because this can lead to damage.

2. Connect the extension cable to the preamplifier and to the main unit and fasten the connectors with the fastening screw.
3. When mounting the microphone on a tripod, first fasten the microphone holder (supplied with the extension cable) to the tripod. Then insert the extension cable connector into the microphone holder.

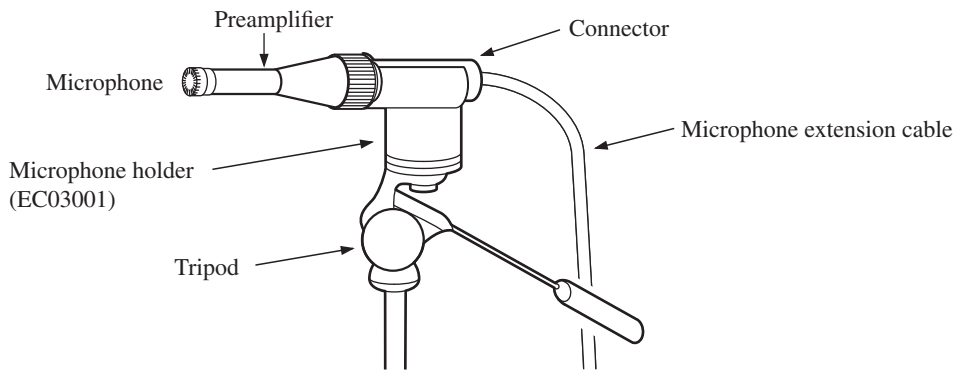

Tripod mounting

For long-term measurements, the unit can be mounted on a camera tripod.

⚠ Caution
Proceed carefully, to avoid dropping the unit or tipping over the tripod.
When using the tripod, ensure that it is stable with the unit mounted on it.
Do not carry the unit with the tripod attached. You may be injured by tripping over or hitting against the unit.

Important
Fasten the unit directly onto a tripod using the tripod screw.
Do not turn the screw diagonally when mounting or removing the unit from the tripod. Turning the screw with excessive force may damage the screw.

Note
It may be difficult to remove batteries while the tripod is used.

Connection to a printer (DPU-414)

Connect the I/O connector on the bottom of the NL-42/NL-52 with an input connector of a printer DPU-414, using the optional printer cable CC-42P as shown below. The performance of other cables is not guaranteed.

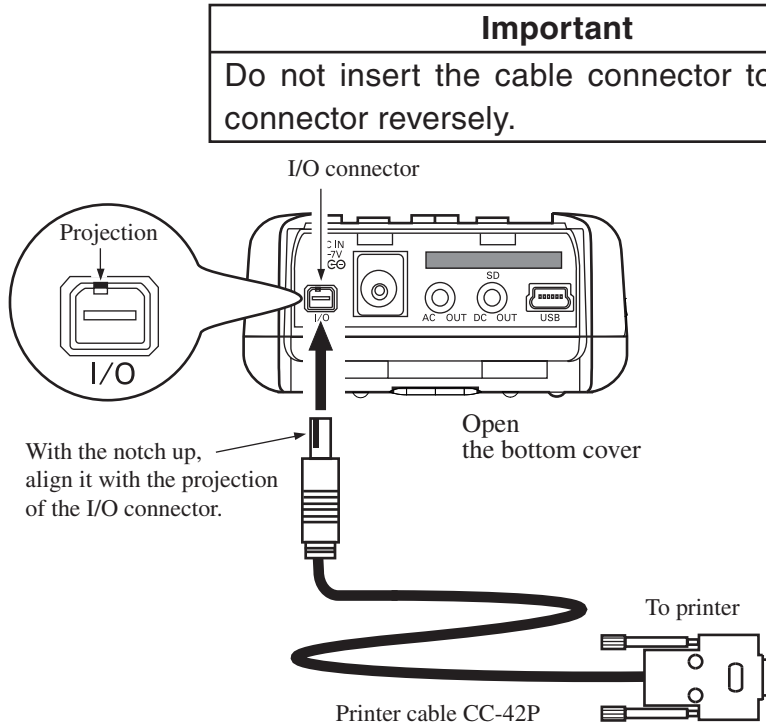

Setting of the sound level meter when using the printer DPU-414

When using DPU-414, set the baud rate for the sound level meter following the steps below.

1. Press the MENU/ENTER key to bring up the menu list screen.
2. Use the Δ / ∇ / \leftarrow / \rightarrow keys to select [I/O] and press the MENU/ENTER key. The I/O screen appears.
3. Use the Δ / ∇ keys to select [Communication Interface] and press the MENU/ENTER key. The communication control function screen appears.
4. Use the Δ / ∇ keys to select [RS-232C] and press the MENU/ENTER key.
5. Select the [Baud rate] on the I/O screen and press the MENU/ENTER key. The baud rate screen appears.
6. Use the Δ / ∇ keys to select [19200bps] and press the MENU/ENTER key.
7. Press the START/STOP key to return to the measurement screen.

Setting the software DIP switches of the DPU-414

Turn on the power while holding down the ON LINE key of the DPU-414.

A printout showing the current status of the printer is produced.

An example showing suitable software DIP switch settings for use of the printer with the NL-42/NL-52 is shown below. (The actual printout will be in a different font.)

[DIP SW setting mode]

Dip SW-1

1 (OFF)	:	Input = Serial
2 (ON)	:	Printing Speed = High
3 (ON)	:	Auto Loading = ON
4 (OFF)	:	Auto LF = OFF
5 (ON)	:	Setting Command = Enable
6 (OFF)	:	Printing
7 (ON)	:	Density
8 (ON)	:	100 %

Dip SW-2

1 (OFF)	:	Printing Columns = 80
2 (ON)	:	User Font Back-up = ON
3 (ON)	:	Character Select = Normal
4 (ON)	:	Zero = Normal
5 (ON)	:	International
6 (ON)	:	Character
7 (ON)	:	Set
8 (ON)	:	=Japan

Dip SW-3

1 (ON)	:	Data Length = 8 bits
2 (ON)	:	Parity Setting = No
3 (OFF)	:	Parity Condition = Even
4 (OFF)	:	Busy Control = XON / XOFF
5 (OFF)	:	Baud
6 (ON)	:	Rate
7 (ON)	:	Select
8 (OFF)	:	= 19200 bps

For details, please refer to the documentation of the DPU-414.

Connection to a level recorder (LR-07, LR-20A) and data recorder (DA-20, DA-21, DA-40)

Connect the AC OUT connector on the bottom of the NL-42/NL-52 with an input connector of level recorder (LR-07, LR-20A) and data recorder (DA-20, DA-21, DA-40), using the optional BNC - Pin output code CC-24 as shown below. The performance of other cables is not guaranteed.

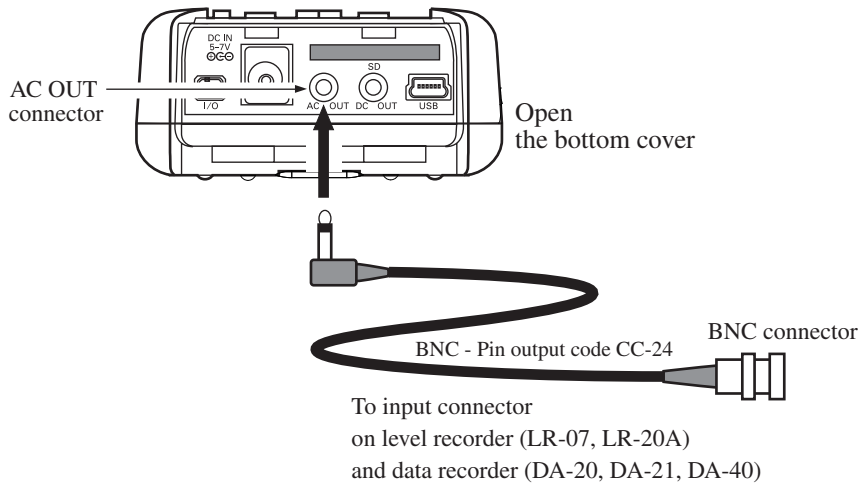

Connection to a computer

Connect the USB connector on the bottom of the NL-42/NL-52 with a USB connector of a computer, using the optional (generic) A - mini B USB cable as shown below.

An SD memory card inserted in the unit will be recognized as a removable disk by the computer when connected via USB, without having to install a USB driver.

Note

If Auto mode store is being carried out, the unit will not be recognized as a removable disk by the computer.

To control the setting of the sound level meter with USB commands using the communication function, select I/O from the menu and set the [Communication Interface] to USB.

For detail using the communication function, refer to the serial interface manual for the unit.

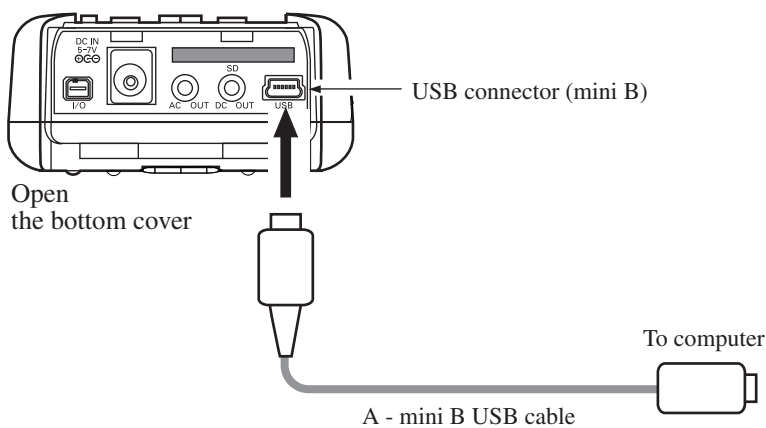

Setting the date and time

The unit incorporates a clock which allows recording the date and time along with measurement data.

Set the date and time as described below.

1. Press the MENU/ENTER key to bring up the menu list screen.
2. Use the $\Delta/\nabla/\triangleleft/\triangleright$ keys to select [System (Language)] and press the MENU/ENTER key. The system screen appears.
3. Use the Δ/∇ keys to select [Clock Setting] and press the MENU/ENTER key. The clock setting screen appears.
4. Use the $\triangleleft/\triangleright$ keys to select [Year], [Month], [Day], [Hour], [Minute] and [Second].
5. Use the Δ/∇ keys to change the setting of the selected item.
6. Repeat the steps 4 and 5. Press the MENU/ENTER key to complete the setting change. The clock starts moving with the new setting.
7. Press the START/STOP key to return to the measurement screen.

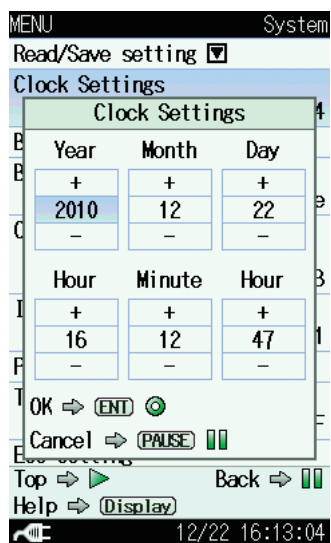

Clock settings screen

Important

If the unit is not to be used for an extended period, the main batteries should be taken out to prevent possible damage due to battery fluid leakage. After reinserting the batteries, be sure to set the date and time.

Note

The clock in this unit has an error of about 1 minute per month. Before measurement, be sure to check and set the time if required.

An internal rechargeable backup battery serves to keep clock setting on the unit. The backup battery is automatically charged by the main batteries, but the retention period for clock setting depends on charging time (see page 13). Full charge of the backup battery requires approximate 24 hours.

Measurement in a dark location

Pressing the LIGHT key will turn on the display backlight, for easier reading in a dark location. The backlight operation pattern can be controlled via a menu, as follows.

1. Press the MENU/ENTER key to bring up the menu list screen.
2. Use the $\Delta/\nabla/\triangleleft/\triangleright$ keys to select [System (Language)] and press the MENU/ENTER key. The system screen appears.
3. Use the Δ/∇ keys to select [Backlight/LCD Settings] and press the MENU/ENTER key. The backlight/LCD settings screen appears.
4. Use the Δ/∇ keys to select [Backlight Auto Off] and press the MENU/ENTER key. The backlight auto off screen appears.
5. Use the Δ/∇ keys to select the automatic turn-off interval (30 sec, 3 min, Continue) and press the MENU/ENTER key.
6. Use the Δ/∇ keys to select [Backlight brightness] and press the MENU/ENTER key. The level of brightness screen appears.
7. Use the Δ/∇ keys to select the level of brightness (level 1 to level 4) and press the MENU/ENTER key. (level 1 is dark, and level 4 is bright.)
8. Press the START/STOP key to return to the measurement screen.

To turn the backlight off before the automatic turn-off point, press the LIGHT key.

The [level 4] setting for backlight brightness will reduce battery life by about 30 percent, and the [level 1] setting by about 5 percent.

Note
When there is only one segment (red) on the battery status indicator, the display backlight does not turn on.

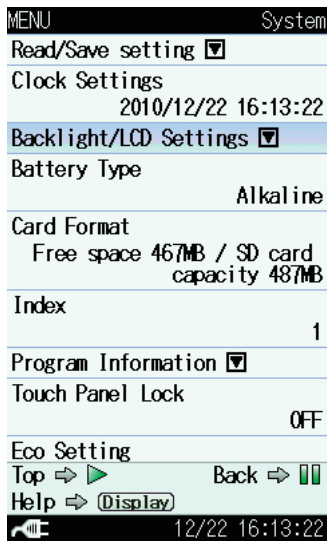

System screen

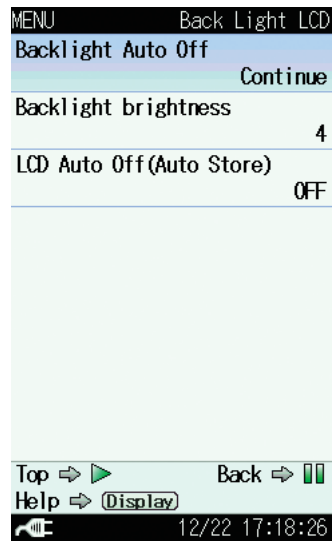

Backlight/LCD settings screen

Sub channel settings

When the sub channel is set to ON, the sound level will be shown using the frequency weighting and time weighting settings made for the sub channel, along with the main channel sound level display.

To use the sub channel, you must make certain settings on a menu screen.

1. Press the MENU/ENTER key to bring up the menu list screen.
2. Use the $\Delta/\nabla/\triangleleft/\triangleright$ keys to select [Measure] and press the MENU/ENTER key. The measurement setting screen appears.
3. Use the Δ/∇ keys to select [Sub Channel Settings] and press the MENU/ENTER key. The sub channel settings screen appears.
4. Use the Δ/∇ keys to select [Sub Channel Settings] and press the MENU/ENTER key. The ON/OFF setting screen appears.
5. Use the Δ/∇ keys to select [ON] and press the MENU/ENTER key.
6. Use the Δ/∇ keys to select [Frequency Weighting (Sub)] and press the MENU/ENTER key. The frequency weighting characteristics setting screen appears.
7. Use the Δ/∇ keys to select the frequency weighting characteristics (A, C, Z) and press the MENU/ENTER key.
8. Use the Δ/∇ keys to select [Time Weighting (Sub)] and press the MENU/ENTER key. The time weighting characteristics setting screen appears.
9. Use the Δ/∇ keys to select the time weighting characteristics [F(Fast), S(Slow), I] and press the MENU/ENTER key. (Time weighting I can be selected when frequency weighting A is selected.)
10. Press the START/STOP key to return to the measurement screen.

Note
If the sub channel is not set to “ON”, measurement value are not displayed.
Since the sound level data of sub channel is not saved, it will not be displayed on the recall screen (see pages 67 and 90).
When the optional Extended Function Program NX-42EX is not installed, the time weighting characteristic I (Impulse) cannot be selected.



Measurement setting screen

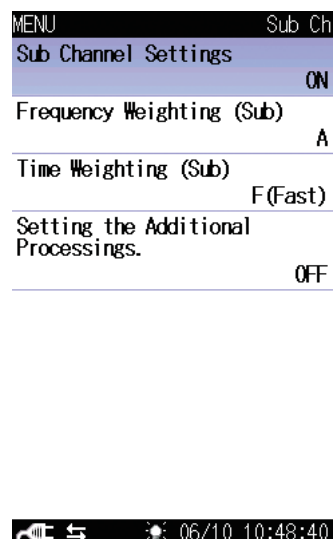

Sub channel settings screen

Additional processing

When the [Sub Channel Settings] is set to ON, one of the following items can be measured with main channel as simultaneous measurement function (see page 80).

- C-weighted equivalent continuous sound level L_{Ceq}
- C-weighted peak sound level L_{Cpeak}
- Z-weighted peak sound level L_{Zpeak}
- I-time-weighted equivalent continuous sound level L_{A1eq}
- Tact-max A-weighted sound level L_{Atm5}
- Maximum I-time-weighted equivalent continuous sound level L_{A1max}

(When the optional Extended Function Program NX-42EX is not installed, L_{A1eq} and L_{A1max} cannot be measured.)

The frequency response of additional processing is associated with that of sub channel. Therefore, L_{A1eq} or L_{A1max} can be selected when the sub channel has A-weighting, L_{Ceq} or L_{Cpeak} can be selected when the sub channel has C-weighting, L_{Zpeak} can be selected when the sub channel has Z-weighting.

Note
<p>If the additional processing value is not set to “ON” on the display menu, measurement data of additional processing is not stored.</p>

Eco setting (Power-saving mode)

The Eco setting enables the power saving feature. A long-time measurement can be performed using batteries only.

1. Press the MENU/ENTER key to bring up the menu list screen.
2. Use the $\Delta/\nabla/\triangleleft/\triangleright$ keys to select [System (Language)] and press the MENU/ENTER key. The system screen appears.
3. Use the Δ/∇ keys to select [Eco Setting] and press the MENU/ENTER key. The confirmation screen appears.
4. Press the MENU/ENTER key to execute the eco setting.
5. Press the START/STOP key to return to the measurement screen.

When the eco setting is executed, the setting of the item is changed automatically as follows.

Sub channel setting	OFF
Backlight auto off	30 sec
Backlight brightness	1
Setting the additional processings	OFF
AC OUT	OFF
DC OUT	OFF
Communication interface	OFF
LCD auto off at auto store	1 min (only when optional NX-42EX is installed)
Comparator	OFF (only when optional NX-42EX is installed)

Comparator output

This is an open collector output that can be used to control external equipment. When the optional Extended Function Program NX-42EX is not installed, the comparator output cannot be set.

1. Press the MENU key to bring up the menu list screen.
2. Use the $\Delta/\nabla/\triangleleft/\triangleright$ keys to select [I/O] and press the MENU/ENTER key. The I/O screen appears.
3. Use the Δ/∇ keys to select [Comparator] and press the MENU/ENTER key. The comparator screen appears.
4. Use the Δ/∇ keys to select [Comparator] and press the MENU/ENTER key. The ON/OFF setting screen appears.
5. Use the Δ/∇ keys to select [ON] and press the MENU/ENTER key.
6. Use the Δ/∇ keys to select [Comparator level] and press the MENU/ENTER key. The comparator level screen appears.
7. Use the $\triangleleft/\triangleright$ keys to select the first digit and use the Δ/∇ keys to set the value.
8. Use the $\triangleleft/\triangleright$ keys to select the two lower digits and use the Δ/∇ keys to set the value. Then press the MENU/ENTER key. (Setting range 25 dB to 130 dB, 1-dB steps)
9. Use the Δ/∇ keys to select [Comparator band] and press the MENU/ENTER key. The comparator band screen appears.
10. Use the Δ/∇ keys to select the comparator band (MAIN AP, SUB AP) and press the MENU/ENTER key.
11. Press the START/STOP key to return to the measurement screen.

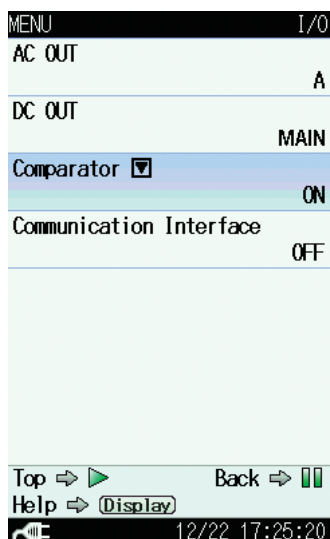

I/O screen



Comparator screen

Connecting external equipment

Connect the I/O connector on the bottom of the NL-42/NL-52 with an input connector of external equipment, using the optional comparator output cable CC-42C as shown below. The performance of other cables is not guaranteed.

Important
Do not insert the cable connector to the I/O connector reversely.

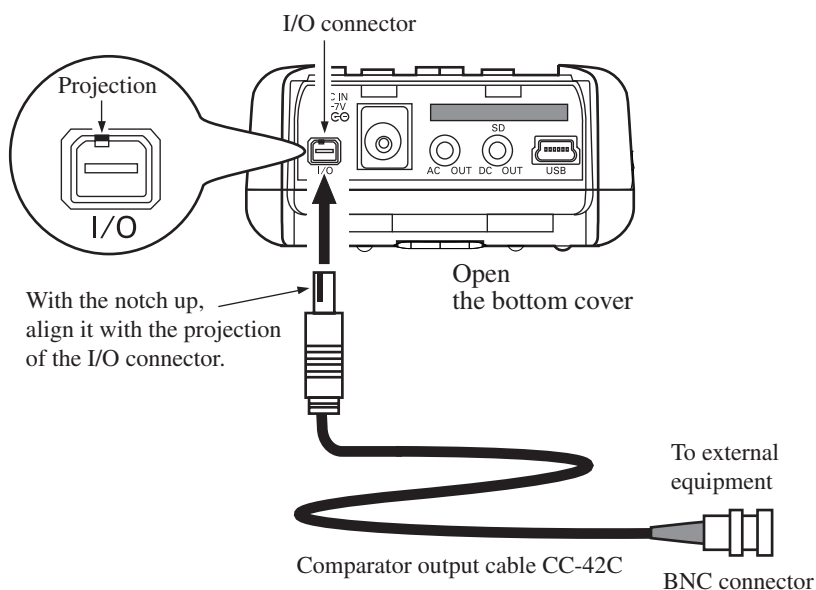

About the comparator output

When the sub channel is OFF, the comparator will not function if sub channel (SUB AP) is selected as comparator band.

The comparator signal output timing pattern is as shown below.

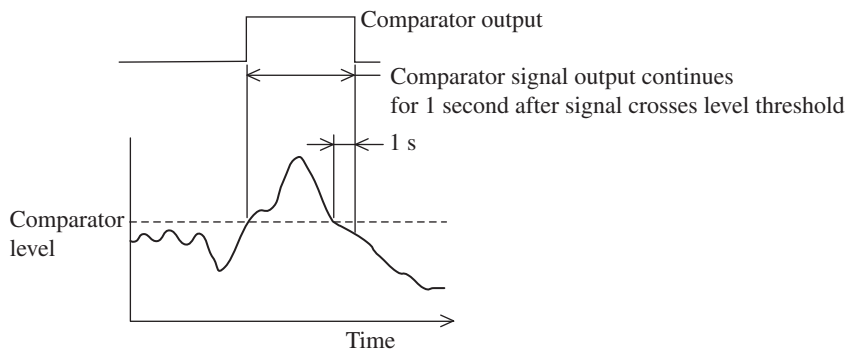

Note

When the sub channel (SUB AP) is selected as comparator band, a comparator level bar indication will be shown above the bar graph, but because the bar graph shows the main channel, the comparator indication and the bar graph indication will not be matched.

Language selection

The language used for displaying messages and menus can be selected as follows.

1. Press the MENU/ENTER key to bring up the menu list screen.
2. Use the $\Delta/\nabla/\triangleleft/\triangleright$ keys to select [System (Language)] and press the MENU/ENTER key. The system screen appears.
3. Use the Δ/∇ keys to select [Language] and press the MENU/ENTER key. The language screen appears.
4. Use the Δ/∇ keys to select the type of language and press the MENU/ENTER key.
5. Press the START/STOP key to return to the measurement screen.
The language selection is memorized by the unit and will be active also the next time the unit is turned on.

Note
Descriptions in this instruction manual are based on the premise that the [Language] is set to [English].

Calibration

Before starting a measurement, the unit must be calibrated. There are two types of calibration, namely electrical calibration using an internally generated signal and acoustic calibration using an external sound calibrator.

Internal calibration (Electrical calibration)

Calibration is carried out using a signal generator (1 kHz, sinusoidal wave) built into the unit.

1. Press the CAL key. A calibration screen such as shown below appears.

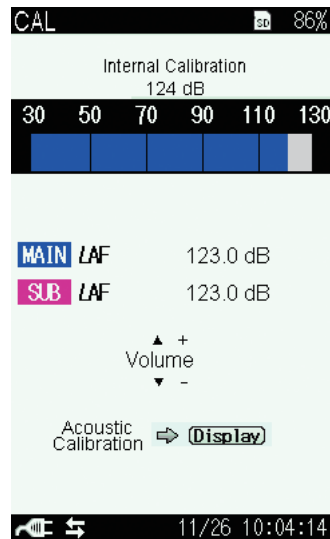

Verify the “Internal Calibration” is displayed in the upper part of the screen.

If “Acoustic Calibration” is shown in the upper part of the screen, press the DISPLAY key. The calibration mode will change to “Internal Calibration”.

2. Confirm that the calibration value indication shows 124 dB steadily. If the bar graph upper limit setting is not 130 dB, a value of [Output Level Range Upper -6 dB] will be flashing as the “124 dB” value on the calibration value indication.
3. Use the Δ/∇ keys to bring the level indication to the specified value (124.0 dB).

4. When calibration to 124.0 dB is completed, press the CAL key once more to return to the measurement screen.

Note
If the bar graph upper limit setting is not 130 dB, bring the level indication to a value that is 6 dB below the upper limit of the bar graph scale.

Signal output for calibration of external equipment

The normal level range setting for calibration is scale upper limit 130 dB, but for calibration of external equipment, another level range setting can also be chosen. In this case, “xx dB” flashes on the calibration value indication.

The calibration value indication will always be 6 dB below the upper limit of the level range setting.

Using the AC or DC output, calibration of connected equipment can be carried out as follows.

1. Press the CAL key.
2. Use the Δ/∇ keys to adjust the level indication to scale upper limit -6 dB.

A calibration signal is supplied at the AC OUT and DC OUT connector on the bottom panel of the unit.

3. Press the CAL key once more to return to the measurement screen.

Note
During a measurement of a quantity other than sound level (including when a triangle symbol is flashing in the top left of the display, and when the unit is in pause mode), calibration cannot be performed. Perform calibration after measurement is completed (START/STOP key has been pressed).

Acoustic calibration (with Sound Calibrator NC-75/NC-74 or Pistonphone NC-72B/NC-72A)

Note

When using the Pistonphone NC-72B/NC-72A, set the frequency weighting of the NL-42/NL-52 as Z or C.

For acoustic calibration, a sound calibrator or a pistonphone is mounted to the microphone of the NL-42/NL-52, and adjustment is performed so that the reading of the meter is equal to the sound pressure level inside the coupler.

1. Turn off the Sound Calibrator NC-75/NC-74 or the Pistonphone NC-72B/NC-72A.
2. Mount the 1/2-inch adapter on the coupler of the Sound Calibrator NC-75/NC-74 or the Pistonphone NC-72B/NC-72A.

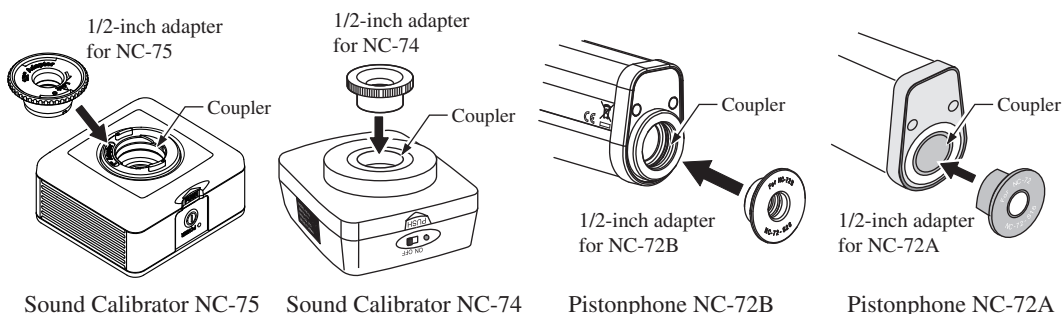

3. Insert the microphone very carefully and slowly all the way into the coupler.

Important

Be very careful when inserting and removing the microphone to and from the Sound Calibrator NC-75/NC-74 or the Pistonphone NC-72B/NC-72A, to avoid a sudden pressure buildup which could destroy the membrane of the microphone.

4. Set the power switch of the Sound Calibrator NC-75/NC-74 or the Pistonphone NC-72B/NC-72A to ON.

5. Press the CAL key. A calibration screen such as shown below appears.

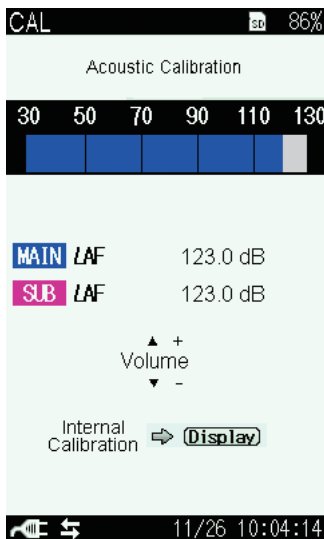

Verify the “Acoustic Calibration” is displayed in the upper part of the screen.

If “Internal Calibration” is shown in the upper part of the screen, press the DISPLAY key. The calibration mode will change to “Acoustic Calibration”.

6. Use the Δ/∇ keys to adjust the reading of the NL-42/NL-52 to the value shown below.
 - When using NC-75/NC-74:
 - NL-42: 93.9 dB NL-52: 94.0 dB
 - When using NC-72B/NC-72A:
 - NL-42: 114.0 dB NL-52: 114.0 dB
7. Press the CAL key. The measurement screen returns.
8. Turn off the Sound Calibrator NC-75/NC-74 or the Pistonphone NC-72B/NC-72A and the NL-42/NL-52.
9. Remove the microphone very carefully and slowly from the coupler.

Note
For details on the Sound Calibrator NC-75/NC-74 or the Pistonphone NC-72B/NC-72A, refer to the documentation of that product.
For doing an acoustic calibration, when the sound level meter is inserted vertically into the end of the sound calibrator NC-75/74 (or pistonphone NC-72B/NC-72A), please do not leave a gap, and keep it straight.

Reading the Display

Measurement screen display

The illustration below shows all elements of the display for explanation purposes. In actual operation, such a screen will not be shown.

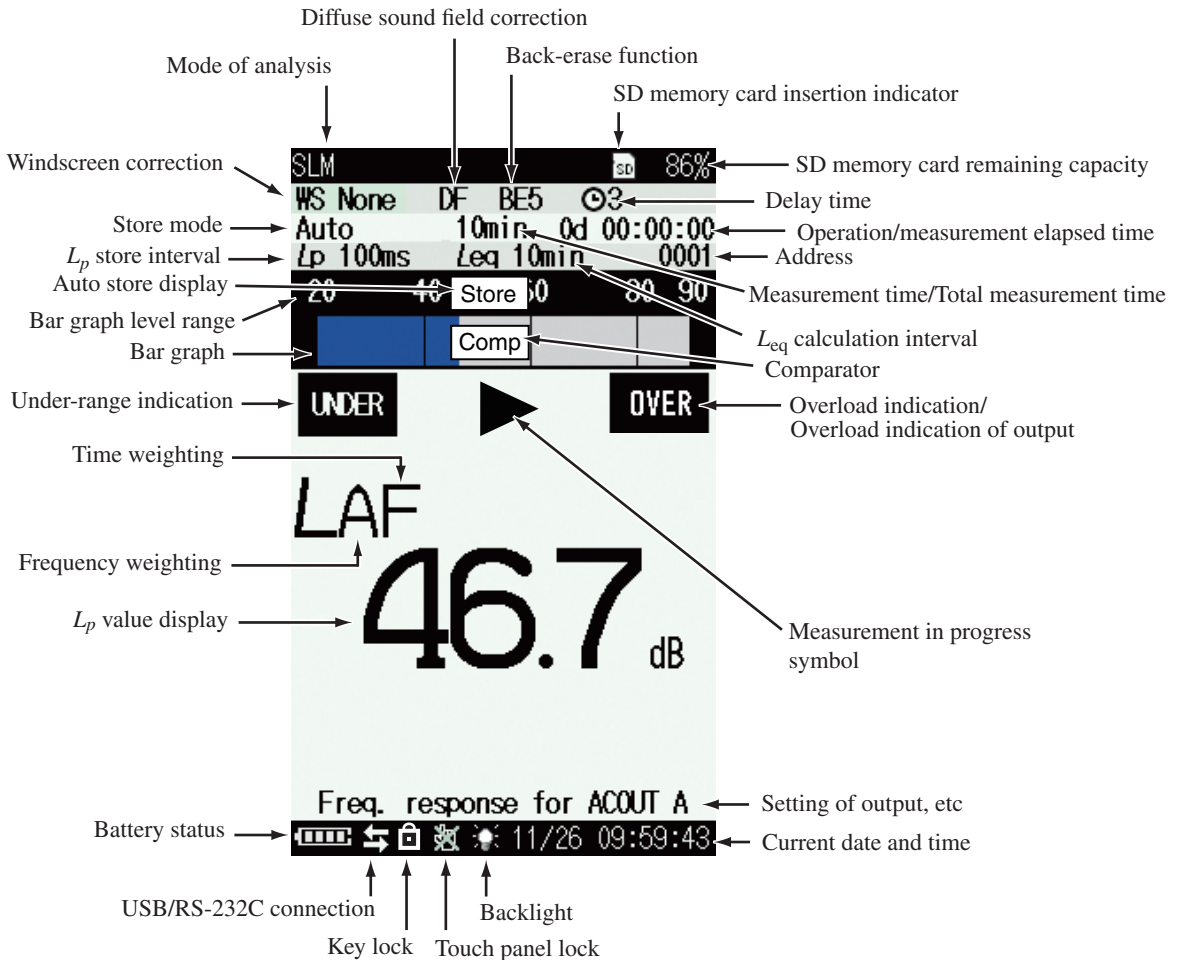

Diffuse sound field correction

Indicates that the unit has been set up for measurement in a diffuse sound field (see page 17).

Back-erase function

Indicates that the back-erase function has been set to 1 s, 3 s, or 5 s (see page 76).

SD memory card insertion indicator

Shown when an SD memory card is inserted in the unit (see page 18).

SD memory card remaining capacity

Shows the remaining capacity of an inserted SD memory card.

Delay time

Shows the delayed measurement time set by “Delay Time” (see page 75).

Operation/measurement elapsed time

Shows the elapsed time from the start of measurement.

Address

Shows the current memory address. In manual store mode, the indication is red if there are data in that address.

Measurement time/Total measurement time

When the store mode is Manual, the measurement time is displayed (see page 89).

When the store mode is Auto, the total measurement time is displayed (see page 93).

Store mode

Shows the selected mode for storing data in memory (Manual, Auto, or Timer Auto) (see page 85).

Note
When the optional Extended Function Program NX-42EX is not installed, the Auto and Timer Auto cannot be selected.

L_{eq} calculation interval

When the store mode is Auto or Timer Auto, the L_{eq} calculation interval is displayed (see pages 93, 98).

L_p store interval

When the store mode is Auto or Timer Auto, the L_p store interval is displayed. (see pages 93, 98)

Comparator

When the comparator function has been set to ON, the comparator level is shown as an orange line on the bar graph. When a signal exceeds that level, the indication [Comp] appears, and a signal is output from the I/O connector on the bottom panel (see page 33).

Note
When the optional Extended Function Program NX-42EX is not installed, the comparator cannot be selected.

Overload indication

When a sound level overload condition is detected, the indication **OVER** (white on black) is shown for at least 1 second.

If processed data contain signal overload data, the indication **OVER** is shown. This indication remains on the processed data display screen until the next processing measurement is started.

Overload indication of output

When a sound level overload condition over the upper limit of bargraph is detected, the indication **OUTPUT OVER** (white on black) is shown for at least 1 second. If this indication appears, increase the bargraph range setting. The overload indication of output is only available when the AC output, DC output, or waveform recording function is set to ON.

Measurement in progress symbol

When a measurement is in progress, the ► symbol flashes. The indicator LED also flashes in red.

During auto store, the ► symbol also flashes. The indicator LED flashes in red.

During measurement standby, the ■ symbol is shown.

During measurement pause, the || symbol is shown. The indicator LED flashes in blue.

Setting of output, etc

Pressing and holding the DISPLAY key changes alternately the following indications: The number of waveform recording, Freq. response for AC OUT, The number of waveform recording...

- The number of waveform recording (during measurement only)

When the [Wave Rec Mode] on the Wave recording screen was selected, the number of recorded WAV files is shown here (only when optional NX-42WR is installed).

- Freq. response for AC OUT

When the frequency weighting characteristic was selected on the [AC OUT] of the [I/O] menu screen, the selected characteristic is shown here.

Current date and time

Shows the current date and time.

Backlight

Indicates that the display backlight has been lit up (see page 27).

Touch panel lock

Indicates that the touch panel lock function has been set to ON. Touch panel operations are disabled while this symbol is displayed (see page 53).

Key lock

Indicates that the key lock function has been set to ON (see page 7).

USB/RS-232C connection

Indicates that the communication control function has been set to USB or RS-232C (see page 58).

Battery status

When the unit is operated on battery power, you should regularly check this indication. The number of white segments will decrease as the batteries get used up. When the indication starts to flash in red, replace the batteries with a fresh set.

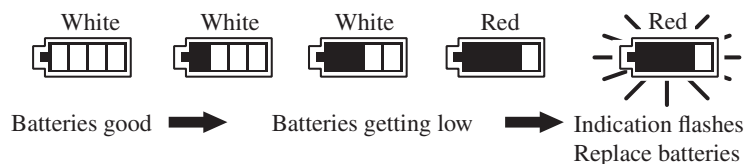

When the unit is being powered from an AC adapter or a battery pack, the  symbol is shown.

L_p value display

Shows the measured sound level in the main channel. (The display is updated every second.)

Frequency weighting

Indicates the main channel frequency weighting characteristic.

A: A-weighting, C: C-weighting, Z: Z-weighting (Flat response)

Time weighting

Indicates the main channel time weighting characteristic.

F: Fast, S: Slow

Under-range indication

When a signal under-range condition is detected, the indication **UNDER** (white on black) is shown.

If processed data contain signal under-range data, the indication **UNDER** is shown. This indication remains on the processed data display screen until the next processing measurement is started.

Note
When the [sub channel settings] is set to On, the under-range indication is based on the frequency weighted measurement value in the channel in which the measurement lower limit is lower.
When A-weighting and C-weighting, or A-weighting and Z-weighting are selected (in either channel), the under-range indication is based on the A-weighted measurement value. When C-weighting and Z-weighting are selected, the under-range indication is based on the C-weighted measurement value.

Bar graph

Shows the sound level as a bar graph indication. (The display is updated every 100 msec.)

Bar graph level range

Shows the upper and lower limit of the bar graph. The range can be changed using the [Display] setting in the menu list screen (see pages 55 to 56).

Auto store display

When the store mode is Auto or Timer Auto, this indication flashes during measurement. The indication is off when data are stored in memory.

Windscreen correction

Shows the model of windscreen set by windscreen correction function (see page 16).

Mode of analysis

Indicates the condition of the display screen.

Sub channel display screen

The sub channel L_p value can be displayed on the measurement screen by setting [Sub Channel Settings] to ON on the [Measure] screen from the menu (see page 29).

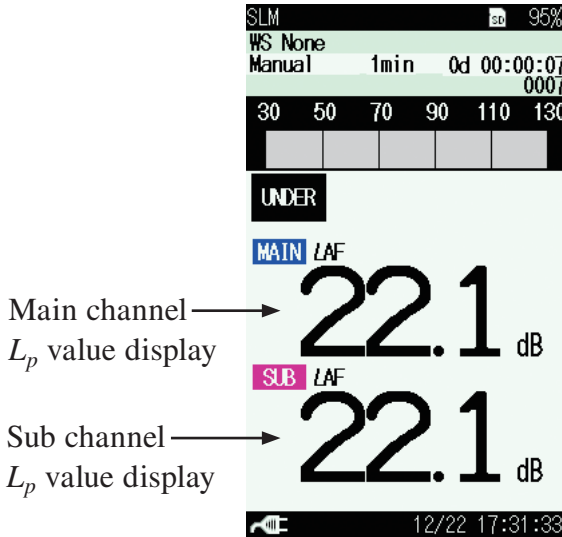

Processed data display screen other than L_p value

The measurement items, which are set to ON on the [Display] screen from the menu, will be displayed on the measurement screen by pressing the DISPLAY key (see page 54).

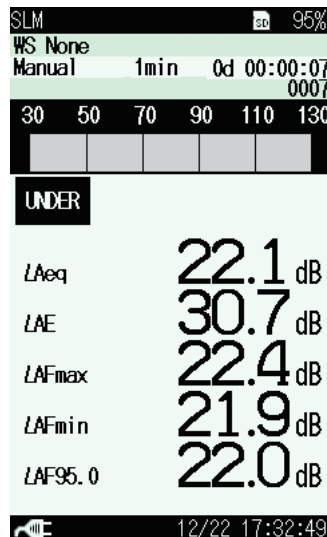

Time-Level screen

While [Time-Level] is set to ON on the [Display] screen from the menu, the time-level screen will be displayed by pressing the DISPLAY key on the measurement screen (see page 55).

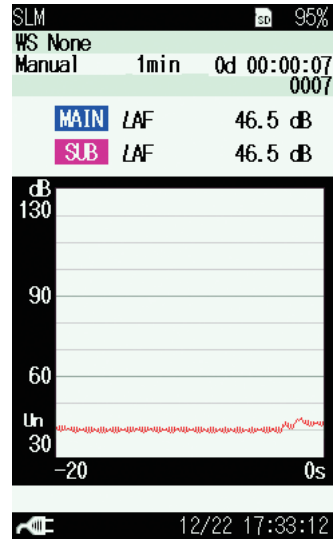

Indicator messages

When keys such as START/STOP or PAUSE/CONT are pressed, indicator messages such as shown below will appear on the display for about 1 second.

START	When START/STOP key was pressed and processing has started
STOP	When START/STOP key was pressed and processing has ended
PAUSE	When PAUSE/CONT key was pressed and operation is paused
BACK ERASE	When PAUSE/CONT key was pressed during processing (back-erase function is selected)
CONTINUE	When PAUSE/CONT key was pressed and processing has resumed

Menu list screen

When the measurement screen is displayed, pressing the MENU/ENTER key brings up the menu list screen as shown below.

Use the $\Delta/\nabla/\triangleleft/\triangleright$ keys to select the desired menu and press the MENU/ENTER key.

Pressing the DISPLAY key displays explanation screen of the item that has been selected.

Pressing the PAUSE/CONT key or the START/STOP key switches back to the measurement screen.



The following settings of frequency weighting, time weighting and sub channel measurement ON/OFF can be done with the touch panel. (The current setting is shown when the menu list screen is displayed.) Touch the screen directly with your finger.

Freq

Selects the frequency weighting characteristic for the main channel.

Each press of the “Freq” on the screen with the finger cycles through the following settings.

“A”, “C”, “Z”

Time

Selects the time weighting characteristic for the main channel.

Each press of the “Time” on the screen with the finger cycles through the following settings.

“F”, “S”

Sub

Selects whether or not to display the sound level of the sub channel measurement.

Each press of the “Sub” on the screen with the finger cycles through the ON and OFF.

System (Language)

This screen sets the item concerning the system of the unit.

Use the $\Delta/\nabla/\triangleleft/\triangleright$ keys to select [System (Language)] and press the MENU/ENTER key. The system screen appears.

Each item of the system screen is selected using the Δ/∇ key.

Pressing the DISPLAY key displays explanation screen of the item that has been selected.

Pressing the PAUSE/CONT key switches back to the menu list screen.

Pressing the START/STOP key switches back to the measurement screen.

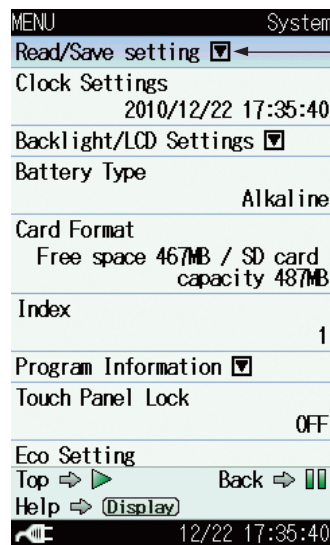

Symbol shows that a next menu level exists. Use $\Delta/\nabla/\triangleleft/\triangleright$ keys to select the item and press the MENU/ENT key. The next menu level appears.

Read/Save setting ▾

Displays the screen to save a setting for the unit and read the saved setting. Select [Read/Save setting] and press the MENU/ENTER key. The setting operation screen appears (see page 114).

Clock Settings

Displays the screen to set date and time of the internal clock of the unit. Select [Clock Settings] and press the MENU/ENTER key. The clock settings screen appears (see page 26).

Backlight/LCD Settings ▾

Displays the screen to set the function of the backlight and the LCD of the unit.

Select [Backlight/LCD Settings] and press the MENU/ENTER key. The backlight/LCD settings screen appears (see page 27).

Battery Type

Displays the screen to select the type of battery used for the unit. The battery power corresponding to the selected battery is displayed on the measurement screen.

Select [Battery type] and press the MENU/ENTER key. The battery type screen appears.

Use the \triangle/∇ keys to select the battery type (Alkaline, Ni-MH[Nickel-metal hydride]) and press the MENU/ENTER key.

Card Format (can only be selected when SD memory card is inserted)

Formats the inserted SD memory card.

Select [Card Format] and press the MENU/ENTER key. The confirmation screen appears.

Press the MENU/ENTER key to format the card.

Free space / SD card capacity

Displays the free space and the memory capacity of the inserted SD memory card. The both free space and memory capacity are read by the automatic operation, and cannot be changed.

Note
<p>If the following operation is performed while the USB cable is connected, the free space will not be displayed correctly. In this case, cycle the power to the unit, or remove the SD memory card and insert it again.</p> <p>* Have this unit recognized as a removable disk, move the data to a computer and then move the data back to the unit.</p>

Index

Displays the screen to set the identification number of the unit when multiple units are used in a parallel measurement.

Select [Index] and press the MENU/ENTER key. The index screen appears.

Use the ◀/▶ keys to select the digit, and use the △/▽ keys to set the value (1 to 255). Then press the MENU/ENTER key.

Note
Measurement data cannot be selected when recalling it on a unit with a different index number (viewing impossible).

Program Information ▼

Displays the version information screen of the program of the unit.

Select [Program Information] and press the MENU/ENTER key. The program information screen appears.

Touch Panel Lock

Displays the screen to select whether to set the touch panel lock function to prevent a wrong operation effective.

Select [Touch Panel Lock] and press the MENU/ENTER key. The ON/OFF setting screen appears.

Use the △/▽ keys to select the ON/OFF setting and press the MENU/ENTER key.

Eco Setting (Power saving mode)

Enters the power-saving mode.

Select [Eco Setting] and press the MENU/ENTER key. The confirmation screen appears (see page 32).

Language

Displays the screen to select the language used for displaying messages and menus.

Select [Language] and press the MENU/ENTER key. The language screen appears (see page 36).

Display

This screen sets the measurement values displayed on the measurement screen. Use the $\Delta/\nabla/\leftarrow/\rightarrow$ keys to select [Display] and press the MENU/ENTER key. The display screen appears.

Each item of the display screen is selected using the Δ/∇ key.

Pressing the DISPLAY key displays explanation screen of the item that has been selected.

Pressing the PAUSE/CONT key switches back to the menu list screen.

Pressing the START/STOP key switches back to the measurement screen.

MENU	Display
<i>L</i> eq	ON
<i>L</i> E	ON
<i>L</i> max	ON
<i>L</i> min	ON
<i>L</i> 5	OFF
<i>L</i> 10	OFF
<i>L</i> 50	OFF
<i>L</i> 90	OFF
Top \Rightarrow \blacktriangleright	Back \Rightarrow \blacksquare
Help \Rightarrow (Display)	
12/22 17:36:10	

MENU	Display
	OFF
<i>L</i> 50	OFF
<i>L</i> 90	OFF
<i>L</i> 95	ON
Time-Level	ON
Time Scale	20s
Output Level Range Upper	130dB
Output Level Range Lower	30dB
Top \Rightarrow \blacktriangleright	Back \Rightarrow \blacksquare
Help \Rightarrow (Display)	
12/22 17:36:25	

*L*eq, *L*E, *L*max, *L*min, Additional processing (processing setting is ON only)

Displays the screen to select the measurement value displayed on the measurement screen.

Select the measurement value (*L*eq, *L*E, *L*max, *L*min, Additional processing) and press the MENU/ENTER key. The ON/OFF setting screen appears. Use the Δ/∇ keys to select the ON/OFF setting and press the MENU/ENTER key.

LN1, LN2, LN3, LN4, LN5

Displays the screen to select the percentile sound level displayed on the measurement screen.

To set the *L1* to *L99* value for *LN1* to *LN5*, use the Δ/∇ keys to change the value (only *LN5* can be set the value from *L0.1* to *L99.9*).

Select the percentile sound level (*LN1* to *LN5*) and press the MENU/ENTER key. The ON/OFF setting and value setting screen appears.

Use the Δ/∇ keys to select the ON/OFF setting, and use the Δ/∇ keys to set the value (1 to 99). Then press the MENU/ENTER key.

Time-Level

Displays the screen to select whether to display the time-level screen.

Select [Time-Level] and press the MENU/ENTER key. The ON/OFF setting screen appears (see page 47).

Use the Δ/∇ keys to select the ON/OFF setting and press the MENU/ENTER key.

Time Scale

Displays the screen to select time-scale of time-level screen when [Time-Level] is set to “ON”.

Select [Time Scale] and press the MENU/ENTER key. The time scale screen appears.

Use the Δ/∇ keys to select the time scale (20s, 1min, 2min) and press the MENU/ENTER key.

Output Level Range Upper

Displays the screen to set the upper bound value of the bar graph and fullscale of output voltage on the measurement screen.

Select [Output Level Range Upper] and press the MENU/ENTER key. The upper limit of bar graph screen appears.

Use the Δ/∇ keys to set the value (70 to 130, 10 dB step). Then press the MENU/ENTER key.

The value of upper limit cannot be set the value set by the “Output Level Range Lower” or less.

Output Level Range Lower

Displays the screen to set the lower bound value of the bar graph on the measurement screen.

Select [Output Level Range Lower] and press the MENU/ENTER key. The lower limit of bar graph screen appears.

Use the Δ/∇ keys to set the value (20 to 80, 10 dB step). Then press the MENU/ENTER key.

The value of lower limit cannot be set the value set by the “Output Level Range Upper” or more.

I/O

This screen sets the type of output signal etc.

Use the $\Delta/\nabla/\triangleleft/\triangleright$ keys to select [I/O] and press the MENU/ENTER key. The I/O screen appears.

Each item of the I/O screen is selected using the Δ/∇ key.

Pressing the DISPLAY key displays explanation screen of the item that has been selected.

Pressing the PAUSE/CONT key switches back to the menu list screen.

Pressing the START/STOP key switches back to the measurement screen.

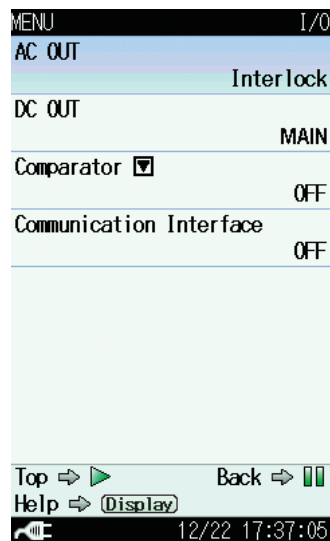

AC OUT

Displays the screen to select the type of frequency weighting characteristic of the signal output from the AC OUT connector of the unit.

Select [AC OUT] and press the MENU/ENTER key. The AC OUT setting screen appears (see page 106).

Use the Δ/∇ keys to select the frequency weighting characteristic (OFF, Inter lock, A, C, Z) and press the MENU/ENTER key.

DC OUT

Displays the screen to select the DC signal output from the DC OUT connector of the unit.

Select [DC OUT] and press the MENU/ENTER key. The DC OUT setting screen appears (see page 108).

Use the Δ/∇ keys to select the DC signal output (OFF or MAIN) and press the MENU/ENTER key.

Comparator

Displays the screen to set the comparator signal output (open collector output can be used to control external equipment) from the I/O connector of the unit.

Select [Comparator] and press the MENU/ENTER key. The comparator screen appears (see page 33).

Note
When the optional Extended Function Program NX-42EX is not installed, the comparator cannot be selected.

Communication Interface

Displays the screen to select a type of communication with a computer or printer to be connected to the unit.

Select [Communication Interface] and press the MENU/ENTER key. The communication interface screen appears.

Use the Δ/∇ keys to select the communication type (OFF, USB, RS-232C) and press the MENU/ENTER key.

Baud rate

Displays the screen to select the baud rate value when [Communication Interface] is set to “RS-232C”.

Select [Baud rate] and press the MENU/ENTER key. The baud rate screen appears.

Use the Δ/∇ keys to select the baud rate value (9600bps, 19200bps, 38400bps, 57600bps, 115200bps) and press the MENU/ENTER key.

Store

This screen sets the mode that stores the operation result data.

Use the $\Delta/\nabla/\triangleleft/\triangleright$ keys to select [Store] and press the MENU/ENTER key.

The store screen appears.

Each item of the store screen is selected using the Δ/∇ key.

Pressing the DISPLAY key displays explanation screen of the item that has been selected.

Pressing the PAUSE/CONT key switches back to the menu list screen.

Pressing the START/STOP key switches back to the measurement screen.

As for the store screen, the displayed set item is different depending on the set store mode.

For details, please refer to “Store Operation” on the page 85.



Manual

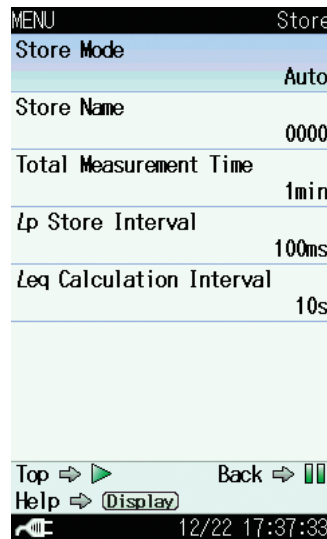

Auto

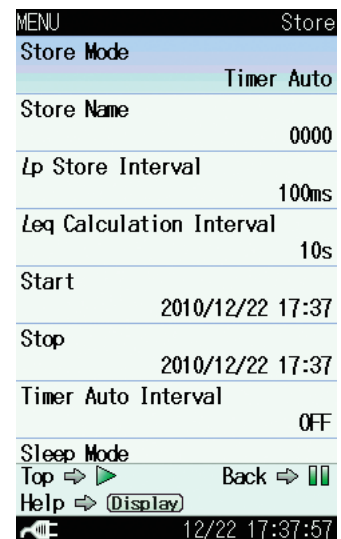

Timer Auto

Store Mode

Displays the screen to select the store mode.

Select [Store Mode] and press the MENU/ENTER key. The store mode setting screen appears.

Use the Δ/∇ keys to select the store mode (Manual, Auto, Timer Auto) and press the MENU/ENTER key.

Note

When the optional Extended Function Program NX-42EX is not installed, the Auto and Timer Auto cannot be selected.

Store Name (common to each mode)

Displays the screen to set the identification number of the store data. (0000 to 9999)

Select [Store Name] and press the MENU/ENTER key. The store name screen appears.

The store name cannot be set in manual mode when an SD card is not inserted.

Measurement Time (Manual mode)

Displays the screen to select the measurement time in the Manual mode. Select [Measurement Time] and press the MENU/ENTER key. The measurement time screen appears.

Total Measurement Time (Auto mode)

Displays the screen to select the total measurement time in the auto mode. Select [Total Measurement Time] and press the MENU/ENTER key. The total measurement time screen appears.

User setting (Manual mode and Auto mode)

When [Manual] is selected from [Measurement Time] of the Manual mode or [Total Measurement Time] of the Auto mode, the user setting items will be displayed and measurement time can be set arbitrarily.

The maximum settable time is 24 hours with the Manual mode and 1000 hours with the Auto mode.

L_p Store Interval (Auto mode and Timer Auto mode)

Displays the screen to select the L_p store interval in the Auto mode or Timer Auto mode.

Select [L_p Store Interval] and press the MENU/ENTER key. The L_p store interval screen appears.

L_{eq} Calculation Interval (Auto mode and Timer Auto mode)

Displays the screen to select the L_{eq} calculation interval in the Auto mode or Timer Auto mode.

Select [L_{eq} Calculation Interval] and press the MENU/ENTER key. The L_{eq} calculation interval screen appears.

Start (Timer Auto mode)

Displays the screen to set the measurement start time in the Timer Auto mode.

Select [Start] and press the MENU/ENTER key. The start time setting screen appears.

When the start time setting screen is displayed for the first time, current time is indicated.

Stop (Timer Auto mode)

Displays the screen to set the measurement stop time in the Timer Auto mode.

Select [Stop] and press the MENU/ENTER key. The stop time setting screen appears.

Timer Auto Interval (Timer Auto mode)

Displays the screen to select the timer auto interval in the Timer Auto mode.

Select [Timer Auto Interval] and press the MENU/ENTER key. The timer auto interval screen appears.

Sleep Mode (Timer Auto mode)

Displays the screen to select whether to set the sleep mode.

Select [Sleep Mode] and press the MENU/ENTER key. The ON/OFF setting screen appears.

When sleep mode is enabled, the unit will enter a power-saving standby condition at 60 seconds after pressing the START/STOP key and during intervals between measurements. In this mode, power consumption is reduced to about 1/10. The LCD panel is off, and the indicator LED flashes in blue once every 5 seconds. 90 seconds before the start of measurement, the unit will wake up and go into standby until measurement begins.

To check the measurement settings in standby condition, press the LIGHT key. The display will come on temporarily and will turn itself off again if no further operation steps are taken. During standby, the LCD panel is off, and the AC and DC outputs, USB connector, RS-232C, comparator functions etc. are also disabled. If one of these functions is required, set the sleep mode to OFF.

Measure

This screen sets the correction of the measurement etc.

Use the $\Delta/\nabla/\triangleleft/\triangleright$ keys to select [Measure] and press the MENU/ENTER key. The measurement setting screen appears.

Each item of the measurement setting screen is selected using the Δ/∇ key. Pressing the DISPLAY key displays explanation screen of the item that has been selected.

Pressing the PAUSE/CONT key switches back to the menu list screen.

Pressing the START/STOP key switches back to the measurement screen.

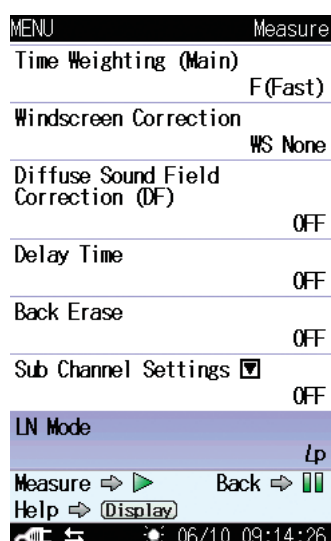
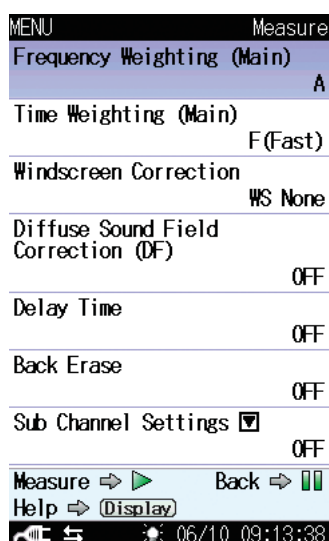

Frequency Weighting (Main)

Displays the screen to select the frequency weighting characteristics for the main channel.

Select [Frequency Weighting (Main)] and press the MENU/ENTER key. The frequency weighting screen appears.

Use the Δ/∇ keys to select the frequency weighting characteristics (A, C, Z) and press the MENU/ENTER key. The same can be performed using the touch panel on the menu list screen.

Time Weighting (Main)

Displays the screen to select the time weighting characteristics for the main channel.

Select [Time Weighting (Main)] and press the MENU/ENTER key. The time weighting screen appears.

Use the Δ/∇ keys to select the time weighting characteristics (F [Fast], S [Slow]) and press the MENU/ENTER key. The same can be performed using the touch panel on the menu list screen.

Windscreen Correction

Displays the screen to select the type of windscreen for windscreen correction.

Select [Windscreen Correction] and press the MENU/ENTER key. The windscreen correction screen appears (see page 16).

Diffuse Sound Field Correction (DF)

Displays the screen to select whether to set the diffuse sound field correction.

Select [Diffuse Sound Field Correction (DF)] and press the MENU/ENTER key. The ON/OFF setting screen appears (see page 17).

Delay Time

Displays the screen to select the delayed measurement time that is an interval starting at the point the start key is pressed.

Select [Delay Time] and press the MENU/ENTER key. The delay time screen appears (see page 75).

Back Erase

Displays the screen to select whether to exclude the data obtained just before a pause of measurement from the processing.

Select [Back Erase] and press the MENU/ENTER key. The back erase screen appears (see page 76).

Sub Channel Settings

Displays the screen to set the sub channel settings and the additional processing settings.

Select [Sub Channel Settings] and press the MENU/ENTER key. The sub channel settings screen appears (see page 29).

LN Mode

Displays the screen to select calculation date for percentile sound level L_N . Select [LN Mode] and press the MENU/ENTER key. The LN mode screen appears.

Use the Δ/∇ keys to select the calculation date (L_p , $L_{eq,1s}$) and press the MENU/ENTER key.

Save/Print

The measurement data or recall data displayed on the screen can be saved or printed on the save/print screen.

Use the Δ / ∇ / \triangleleft / \triangleright keys to select [Save/Print] and press the MENU/ENTER key. The save/print screen appears.

Each item of the save/print screen is selected using the Δ / ∇ key.

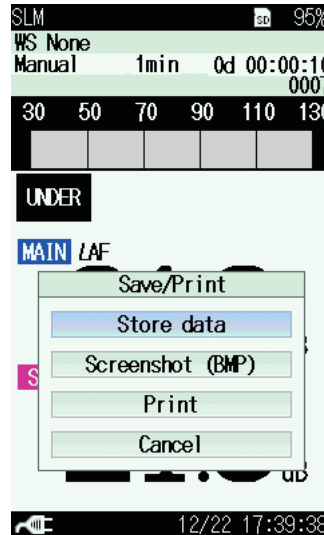

Store data

Stores the displayed measurement data. This is displayed when Manual measurement (processing) data exist.

Select [Store data] and press the MENU/ENTER key.

Screenshot (BMP)

Saves the displayed measurement screen to the internal memory in BMP (bitmap) format (see page 105).

Select [Screenshot (BMP)] and press the MENU/ENTER key.

The data capacity is approximately 300 KB per file.

Print

Prints the displayed measurement data to the printer connected with the unit.

Select [Print] and press the MENU/ENTER key (see page 120).

Cancel

Shuts the save/print screen.

Select [Cancel] and press the MENU/ENTER key.

Option

This screen switches the function from the unit to each program when an optional program is installed.

Use the $\Delta/\nabla/\triangleleft/\triangleright$ keys to select [Option] and press the MENU/ENTER key. The option screen appears.

Each item of the switch function screen is selected using the Δ/∇ key.

Pressing the PAUSE/CONT key switches back to the menu list screen.

Pressing the START/STOP key switches back to the measurement screen.

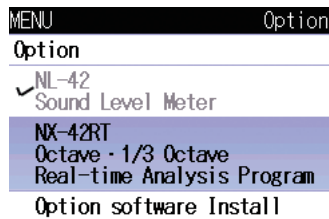

Option

Select a desired program name to switch the function.

Select the program name to be used and press the MENU/ENTER key.

Either NL-42 or NL-52 is displayed depending on the model used.

Program names which are not installed will not be displayed.

Recall

This screen displays a stored data on internal memory or SD memory card. Use the $\Delta/\nabla/\triangleleft/\triangleright$ keys to select [Recall] and press the MENU/ENTER key. The recall screen appears.

Use the $\triangleleft/\triangleright$ keys to select a save location of data and the Δ/∇ keys to select a data file.

Pressing the PAUSE/CONT key switches back to the menu list screen.

Pressing the START/STOP key switches back to the measurement screen.

Note

It may take some time to read data and display the recall screen if the volume of stored data is large.

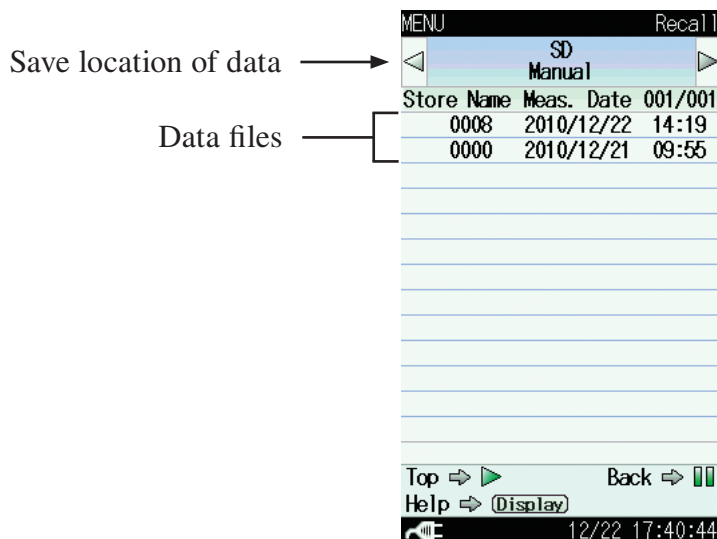

The save location of data can be “Internal Memory Manual”, “SD Manual”, “SD Auto Lp” or “SD Auto Leq”. Without an SD memory card, only “Internal Memory Manual” is available.

Note

If a data file saved on a computer is copied or manipulated, and the copied file is then loaded back into the NL-42/ NL-52, the displayed measurement date and time may not match the actual time stamp of the measurement.

Select data file and press the MENU/ENTER key. The file processing screen appears.

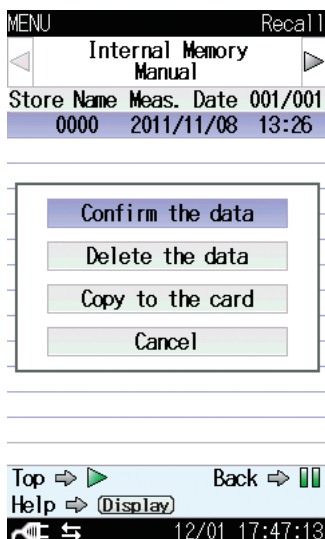

Confirm the data

Displays the measurement data of the selected data file.

Select [Confirm the data] and press the MENU/ENTER key.

You can use the Δ/∇ keys to display data stored at higher or lower address numbers.

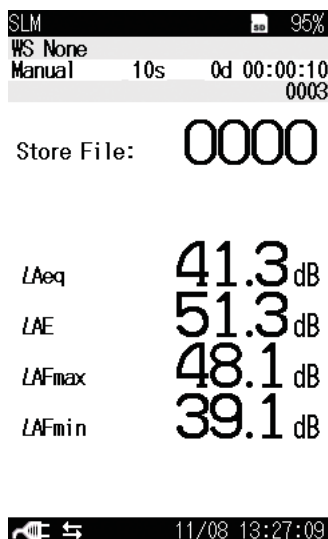

Delete the data

Deletes the selected data file.

Select [Delete the data] and press the MENU/ENTER key. The confirmation screen appears.

Use the Δ/∇ keys to select [Yes] and press the MENU/ENTER key.

Copy to the card (only internal memory data)

Copies the selected internal memory data file to the inserted SD memory card.

Select [Copy to the card] and press the MENU/ENTER key. The store name set screen appears.

Set the store name (number of four digits) at the copy destination and press the MENU/ENTER key.



Cancel

Shuts the file processing screen.

Select [Cancel] and press the MENU/ENTER key.

WR

Select this screen to record the waveform using optional program NX-42WR.

If NX-42WR is not installed, it is not possible to select this screen.

For details, please refer to the instruction manual of Waveform Recording Program NX-42WR.

MENU list items

System (Language)

- Read/Save Settings ▾-----Load Default Settings
 - Internal Memory---- List of setting groups on internal memory
 - Startup File
 - SD---- List of setting groups on SD memory card
- Clock Settings
- Backlight/LCD Settings ▾-----Backlight Auto Off
 - Backlight brightness
 - LCD Auto Off (Auto Store)
- Battery Type---- Alkaline/Ni-MH
- Card Format
- Index
- Program Information ▾-----Model, Version
- Touch Panel Lock
- Eco Setting
- Language----日本語/English/Deutsch/Español/Français/中国語/русский/한국어

Display

- Leq, LE, Lmax, Lmin, (When Additional processing is ON: LCeq, LCpeak, LZpeak, LAIeq^{*1}, LA_{tm5}, LAImax^{*1}), LN1, LN2, LN3, LN4, LN5, Time-Level (When Time-Level is ON: Time Scale), Output Level Range Upper, Output Level Range Lower

I/O

- AC OUT----OFF/Interlock/A/C/Z
- DC OUT----OFF/MAIN
- Comparator^{*1} ▾----- Comparator ON/OFF, Comparator level, Comparator band
- Communication Interface----OFF/USB/RS-232C (When RS-232C is selected: Baud rate)

Store

- Store Mode----Manual/Auto^{*1}/Timer Auto^{*1}
 - Manual----Store Name, Measurement Time
 - Auto----Store Name, Total Measurement Time, Lp Store Interval, Leq Calculation Interval
 - Timer Auto----Store Name, Lp Store Interval, Leq Calculation Interval, Start, Stop, Timer Auto Interval, Sleep Mode

Measure

- Frequency Weighting (Main)----A/C/Z
- Time Weighting (Main)----F(Fast)/S(Slow)
- Windscreen Correction----WS None/WS-10/WS-15/WS-16
- Diffuse Sound Field Correction (DF)
- Delay Time
- Back Erase
- Sub Channel Settings ▾-----Sub Channel Settings ON/OFF, Frequency Weighting (Sub), Time Weighting (Sub), Setting the Additional Processings
- LN Mode----Lp/Leq,1s

Save/Print

Option

Recall

- Recall data list

WR^{*2}

▾-----: Items displayed when proceeding to next menu level

*1: When optional NX-42EX is installed

*2: When optional NX-42WR is installed

Measurement

When using the unit in a mode other than “sound level measurement”, all processing functions provided by the unit (L_{eq} , L_E , L_{max} , L_{min} , L_N) are carried out simultaneously. (However, for the sub channel, only the additional processing function set to “ON” in the menu list screen is carried out.) For example, when equivalent continuous sound level measurement is selected, the sound exposure level and percentile sound level are also determined. However, the time percentage setting for the percentile sound level (5 values) must be selected beforehand.

To display measurement values other than sound level, you need to set desired items to ON on the [Display] screen from the menu list screen.

Also, make sure that the date and time are set correctly, as described on page 26.

Sound level (L_p) measurement

The procedure for sound level measurement is described below.

Preparations as described in the “Preparations” chapter must be completed first.

1. Press the POWER key to turn the unit on.

After the power-on screen has been shown, the measurement screen appears.

The measurement parameter settings that were active before the unit was turned off will be established again. Therefore the actual display may not always be the same.

2. Press the MENU/ENTER key and select the frequency weighting characteristic on the menu list screen. For normal sound level measurements, select the “A” setting.
When Z is selected, the sound pressure level from 10 Hz to 20 kHz is measured with flat characteristics.
When C is selected, the sound pressure level from 31.5 Hz to 8 kHz is measured with flat characteristics.
The frequency weighting characteristic can be set even on the measurement setting screen in the menu list screen.
To set the frequency weighting characteristics for the sub channel, use the measurement setting screen in the menu list screen.
3. Select the time weighting characteristics on the menu list screen. For normal sound level measurements, select the “F(Fast)” setting.
When performing measurements in compliance with IEC or another standard, set the frequency weighting and time weighting characteristics as required by that standard.
The time weighting characteristic can be set even on the measurement setting screen in the menu list screen.
To set the time weighting characteristics for the sub channel, use the measurement setting screen in the menu list screen.
4. Select [Display] on the menu list screen and set the upper and lower limit of the bar graph. The upper and lower limit of the bar graph can be set even on the measurement screen. If the “OUTPUT OVER” indicators appear frequently, change the limit of bar graph setting.
5. The level indication shows the currently measured sound level (sound pressure level). The reading is updated once every second.
The PAUSE/CONT key can be used to pause and resume the updating of level indication. The bar graph indication will be updated also during pause. In the pause condition, a pause symbol (II) appears on the display, and the indicator LED flashes blue.

Equivalent continuous sound level (L_{eq}) measurement

The procedure for equivalent continuous sound level measurement is described below.

Preparations as described in the “Preparations” chapter must be completed first.

1. Turn power to the unit on.
2. Press the MENU/ENTER key and select the frequency weighting characteristic on the menu list screen. For normal sound level measurements, select the “A” setting.

The frequency weighting characteristic can be set even on the measurement setting screen in the menu list screen.

3. Select the time weighting characteristics on the menu list screen. Normally, select the “F(Fast)” setting. (This setting does not affect a measurement result of equivalent continuous sound level.)

The time weighting characteristic can be set even on the measurement setting screen in the menu list screen.

Note
The unit performs high-speed sampling of the sound pressure waveform (20.8 μ s) to determine L_{eq} and L_E . It is therefore not affected by time weighting characteristics.

4. Select [Display] on the menu list screen and set the upper and lower limit of the bar graph. The upper and lower limit of the bar graph can be set even on the measurement screen. If the “OUTPUT OVER” indicators appear frequently, change the limit of bar graph setting.
5. Change the setting to display L_{eq} on the measurement screen. Use the $\Delta/\nabla/\triangleleft/\triangleright$ keys to select [Display] and press the MENU/ENTER key. The display screen appears.
6. Use the Δ/∇ keys to select [L_{eq}] and press the MENU/ENTER key. The ON/OFF setting screen appears.

7. Use the Δ/∇ keys to select [ON] and press the MENU/ENTER key. Press the PAUSE/CONT key to return to the menu list screen.
8. For information about how to store data, refer to the section starting on page 85.
9. Set the measurement time.
Use the $\Delta/\nabla/\triangleleft/\triangleright$ keys to select [Store] and press the MENU/ENTER key. The store screen appears.
10. Use the Δ/∇ keys to select [Store Mode] and press the MENU/ENTER key. The store mode screen appears.
11. Use the Δ/∇ keys to select [Manual] and press the MENU/ENTER key.
12. Use the Δ/∇ keys to select [Measurement Time] and press the MENU/ENTER key. The measurement time screen appears.
13. Use the Δ/∇ keys to select the measurement time (10s [second], 1min [minute], 5min, 10min, 15min, 30min, 1h [hour], 8h, 24h, Manual) and press the MENU/ENTER key.
When “Manual” is selected, arbitrary measurement time can be set (At most for 24 hours).
Press the PAUSE/CONT key to return to the menu list screen.
14. If necessary, set the delayed measurement time. When START/STOP key is pressed, measurement will start after the preset delayed measurement time.
Use the $\Delta/\nabla/\triangleleft/\triangleright$ keys to select [Measure] and press the MENU/ENTER key. The measurement setting screen appears.
15. Use the Δ/∇ keys to select [Delay Time] and press the MENU/ENTER key. The delay time screen appears.

16. Use the Δ/∇ keys to select the delayed measurement time (OFF, 1s [second], 3s, 5s, 10s) and press the MENU/ENTER key.
Press the PAUSE/CONT key to return to the menu list screen.

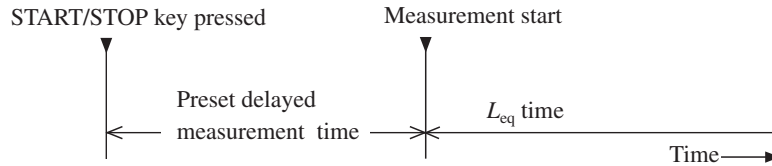

Time graph for delayed measurement time

17. If necessary, set the back erase time. When PAUSE/CONT key is pressed while performing a measurement, the previous data is removed for the preset back erase time.
Use the $\Delta/\nabla/\triangleleft/\triangleright$ keys to select [Measure] and press the MENU/ENTER key. The measurement setting screen appears.
18. Use the Δ/∇ keys to select [Back Erase] and press the MENU/ENTER key. The back erase screen appears.
19. Use the Δ/∇ keys to select the back erase time (OFF, 1s [second], 3s, 5s) and press the MENU/ENTER key.
20. Press the START/STOP key to return to the measurement screen.

21. Press the START/STOP key to start the measurement.

At this point, previous measurement values are cleared.

While the measurement is in progress, the ► symbol flashes and the elapsed time is displayed. In addition, the indicator LED flashes red. When the measurement time set in step 13 has elapsed, the measurement is terminated automatically.

To terminate the measurement before the allocated time, press the START/STOP key.

If signal overload or an under-range condition occurs at least once during measurement, the indication OVER or UNDER appears, to indicate that overload or under-range data are comprised in the processed values.

Important
During measurement, the Δ/∇ keys function as markers (for the case the store mode is set to Auto or Timer Auto, and the L_p store interval is specified). Pressing and holding the Δ/∇ keys can add a marker to specify an interval.
Be sure to complete all settings before starting the measurement.

During measurement, the PAUSE/CONT key can be used to pause and resume the measurement. During pause, the pause symbol (II) is shown. (The paused interval and the back-erase interval are not included in the measurement time.)

If the back-erase function was enabled in steps 17 to 19, using the Time-Level screen is convenient (see page 47). Data excluded by the back-erase function are indicated on the display as follows.

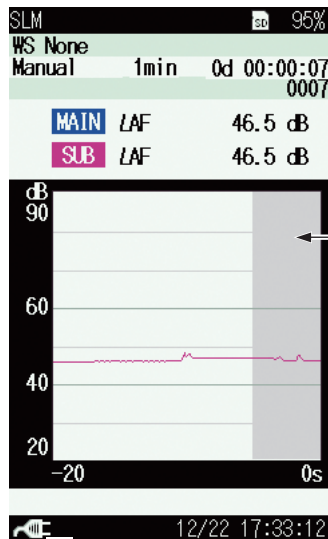

Time-Level screen

Note

<p>If any or several of the following conditions apply, the back-erase function will not be available.</p>
--

- | |
|---|
| <ul style="list-style-type: none"> - Waveform Recording Program NX-42WR is installed and Wave Rec Mode is set to a setting other than “OFF”. - “$L_{eq,1s}$” is selected as LN Mode. - “L_{Atm5}” is selected as additional processing item. |
|---|

22. Press the DISPLAY key to switch the display.

L_{Aeq} means that the equivalent continuous sound level is displayed.

If L_{Aeq} is not shown, check whether L_{eq} is set to ON on the setting screen.

If the indication OVER is shown, the processed data include an overload condition.

If the indication UNDER is shown, the processed data include an under-range condition.

Note

<p>During measurement, you can use the DISPLAY key to check the equivalent continuous sound level as currently calculated. (This applies only to the numeric level display. The bar graph shows the sound level.)</p>

<p>After the measurement is completed, changing the frequency weighting (A/C/Z), time weighting (F[Fast]/S[Slow]) or other settings hides the measurement value.</p>
--

Sound exposure level (L_{AE}), Maximum sound level (L_{max}), Minimum sound level (L_{min}) and Percentile sound level (L_N) measurement

The sound exposure level (L_{AE}), maximum sound level (L_{max}), minimum sound level (L_{min}) and percentile sound level (L_N) are all measured at the same time as the equivalent continuous sound level (L_{eq}).

When the equivalent continuous sound level is measured with desired measurement items set to ON on the [Display] screen from the menu list screen, each measurement value will be displayed on the screen.

Additional processing value measurement

When the sub channel is ON, one of the following processing functions is available in addition to L_{eq} , L_E , L_{max} , L_{min} , and L_N .

C-weighted equivalent continuous sound level	L_{Ceq}
C-weighted peak sound level	L_{Cpeak}
Z-weighted peak sound level	L_{Zpeak}
I-time-weighted equivalent continuous sound level	L_{AIeq}
Tact-max A-weighted sound level	L_{Atm5}
Maximum I-time-weighted equivalent continuous sound level	L_{AImax}

Note
When the optional Extended Function Program NX-42EX is not installed, L_{AIeq} and L_{AImax} cannot be measured.

Settable measurement value of additional processing

The measurement value that can be set by the additional processing is different according to the sub channel settings.

The relation between settable measurement value of additional processing and the sub channel setting is as follows.

Measurement values of additional processing	Sub channel settings		Measurement value for each setting
	Frequency weighting	Time weighting	
L_{eq}	A	I (Impulse)	L_{Aeq}
	C	F (Fast)	L_{Ceq}
	C	S (Slow)	
L_{max}	A	I (Impulse)	L_{AImax}
L_{peak}	C	F (Fast)	L_{Cpeak}
	C	S (Slow)	
	Z	F (Fast)	L_{Zpeak}
	Z	S (Slow)	
L_{tm5}	A	F (Fast)	L_{Atm5}

Note

If the additional processing value is not set to “ON” on the display menu, measurement value are not displayed.

When the optional Extended Function Program NX-42EX is not installed, the time weighting characteristic I (Impulse) cannot be selected.

Measurement value of additional processing is displayed as L_y within store data.

Additional processing value setting procedure

Set the sub channel according to the desired additional processing beforehand (see page 29).

1. Press the MENU/ENTER key to bring up the menu list screen.
2. Use the $\Delta/\nabla/\triangleleft/\triangleright$ keys to select [Measure] and press the MENU/ENTER key. The measurement setting screen appears.
3. Use the Δ/∇ keys to select [Sub Channel Settings] and press the MENU/ENTER key. The sub channel settings screen appears.
4. Use the Δ/∇ keys to select [Setting the Additional Processings] and press the MENU/ENTER key. The setting the additional processings screen appears.
5. Use the Δ/∇ keys to select the additional processing value and press the MENU/ENTER key.
The measurement value that cannot be selected is not displayed.
6. Press the PAUSE/CONT key to return to the menu list screen.
7. Use the $\Delta/\nabla/\triangleleft/\triangleright$ keys to select [Display] and press the MENU/ENTER key. The display screen appears.
8. Select the additional processing value set on the [Setting the additional processings] and press the MENU/ENTER key. The ON/OFF setting screen appears.
9. Use the Δ/∇ keys to select [ON] and press the MENU/ENTER key.
10. Press the START/STOP key to return to the measurement screen.

Card capacity and store time

The measurement duration for which data can be stored on an SD memory card depends on the capacity of the inserted card. Approximate times are listed below.

Using Auto store (when the NX-42EX is installed)

Only L_p store interval set

		SD memory card capacity		
		512 MB	2 GB	32 GB
L_p store interval	100 ms	132 hours	531 hours	8,496 hours
	200 ms	366 hours	1,473 hours	23,568 hours
	1 s	1,832 hours	7,368 hours	117,888 hours
	L_{eq} , 1 s	1,832 hours	7,368 hours	117,888 hours

Only L_{eq} processing interval set

		SD memory card capacity		
		512 MB	2 GB	32 GB
Data sets		3,352,000 sets	13,481,000 sets	215,696,000 sets

Number of bytes per header file

About 1555 bytes per file

When performing waveform recording (when the NX-42WR is installed)

Using Auto store, 16 bit, L_p store interval 100 ms

		SD memory card capacity		
		512 MB	2 GB	32 GB
Sampling frequency (Hz)	48 k	1 hour	4 hours 40 min.	74 hours 40 min.
	24 k	2 hours 10 min.	9 hours 20 min.	149 hours 20 min.
	12 k	4 hours 20 min.	18 hours 50 min.	301 hours 20 min.

The duration of recording with 24 bit becomes shorter than that with 16 bit because the data volume of 24 bit is about 1.5 times more.

Store Operation

The NL-42/NL-52 can store measurement data (processed data such as sound level and equivalent continuous sound level, and measurement parameters such as frequency weighting and time weighting characteristics) in the internal memory or on SD memory card.

This chapter describes how to store data in memory and how to recall data from memory. There are three different modes of storing data, as listed below.

When the optional Extended Function Program NX-42EX is not installed, only the manual mode can be operated.

Store names cannot be set when no SD memory card is inserted.

Important
Use SD memory cards provided by Rion. The performance of other cards is not guaranteed (see page 102).

Note
Prior to measurement, it is recommended first to format the memory card for storing data with this unit (see page 104).

Manual

All processed data except sound level are considered as a single data set, and an operator stores the data set one-by-one manually.

When an operator performs store operation after a measurement, each processed value and measurement condition will be stored with the time value.

If no SD memory card is inserted, the data will be stored in the internal memory of the unit. If an SD memory card is inserted, the data will automatically be stored on the card.

Internal memory capacity: max. 1000 data sets

SD memory card capacity: max. 1000 data sets per store name, max. 100 store names

Auto (only when the NX-42EX is installed)

The processing result which is obtained using the selected sound level and specified interval by the store interval setting will be recorded continuously.

When the following one of conditions occurred, the store is stopped and data is saved.

- When the total measurement time reached the set value.
- When the L_{eq} store reached 999,999 sets.
- When the capacity of the SD memory card became insufficient.

L_p store

The sound level of up to 1,000 hours can be stored continuously and automatically.

This function becomes available when an SD memory card is inserted.

This is useful when recording the sound level waveform.

The store interval can be selected from 100 ms (milliseconds), 200 ms, 1 s (second), $L_{Aeq,1sec}$ (L_{eq} per second).

L_{eq} store

All processed data except sound level are considered as a single data set, and up to 999,999 data sets can be stored continuously and automatically.

This function becomes available when an SD memory card is inserted.

This is suitable for a measurement with a specified long period of time.

The processing interval can be selected from 10 s (seconds), 1 min (minute), 5 min, 10 min, 30 min, 1 h (hour), 8 h, 24 h and manually selected time (up to 24 hours).

Timer Auto (only when the NX-42EX is installed)

Executes Auto store using the set start time and recurrence interval of trigger event.

When the following one of conditions occurred, the store is stopped and data is saved.

- When the total measurement time reached the 1,000 hours.
- When the L_{eq} store reached 999,999 sets.
- When the capacity of the SD memory card became insufficient.

Important
Never turn off power to the unit or remove the SD memory card while a store operation is in progress. Otherwise internal data can be destroyed.
When an SD memory card is inserted in the memory card slot of the unit, use of the internal memory for store is not possible.

Note
A processing start time is used for a time stamp of measurement and processed data. For example, when performing one-minute processing with L_{eq} store, the time stamp 00:01:02 indicates that the data is obtained for one minute from 00:01:02.

Notes for using the data management software AS-60

- Since AS-60 cannot read Manual store data, perform measurement with Auto or Timer Auto store to handle measurement data using AS-60.
- When setting the L_p Store Interval to 200 ms or 1s on the NL-42/52, the AS-60 software calculates the maximum L_p as L_{max} and the minimum L_p as L_{min} from within the measured period.

If you require precise L_{max} , L_{min} values, please set the L_p store interval to 100 ms.

With this setting, L_{max} , L_{min} are measured simultaneously with L_p at every L_p store cycle.

Manual mode operation

Memory store

When an operator performs store operation on the confirmation screen displayed after processing finishes, each processed data will be stored.

If no SD memory card is inserted, the data will be stored in the internal memory of the unit. If an SD memory card is inserted, the data will automatically be stored on the card.

The procedure is as follows.

1. Press the POWER key to turn the unit on.
2. Press the MENU/ENTER key to bring up the menu list screen.
3. Use the $\Delta/\nabla/\triangleleft/\triangleright$ keys to select [Store] and press the MENU/ENTER key. The store screen appears.
4. Use the Δ/∇ keys to select [Store Mode] and press the MENU/ENTER key. The store mode settings screen appears.
5. Use the Δ/∇ keys to select [Manual] and press the MENU/ENTER key. When the optional Extended Function Program NX-42EX is not installed, only the [Manual] can be selected.



Store screen when Manual mode is selected

6. Specify the store name (number of four digits: when SD memory card is inserted).
 - 6-1. Use the Δ/∇ keys to select [Store Name] and press the MENU/ENTER key. The store name screen appears.
 - 6-2. Use the $\triangleleft/\triangleright$ keys to select the first two digits, and use the Δ/∇ keys to set the value.
 - 6-3. Use the $\triangleleft/\triangleright$ keys to select the final two digits, and use the Δ/∇ keys to set the value. Then press the MENU/ENTER key.
7. Set the measurement time.
 - 7-1. Use the Δ/∇ keys to select [Measurement Time] and press the MENU/ENTER key. The measurement time screen appears.
 - 7-2. Use the Δ/∇ keys to select the measurement time (10s, 1min, 5min, 10min, 15min, 30min, 1h, 8h, 24h, Manual) and press the MENU/ENTER key.
 - 7-3. When “Manual” is selected, [User setting] is displayed on the store screen. Select [User setting] and press the MENU/ENTER key.
 - 7-4. The measurement time setting screen appears. Set arbitrary measurement time (At most for 24 hours).
8. Press the START/STOP key to return to the measurement screen.
9. Specify the store address.

The currently selected address is shown on the screen. If the address is shown in red, it already contains data. Take care not to overwrite data that you want to keep.

The Δ/∇ keys can be used to specify the address in the range from 0001 to 1000. Any data already present in the selected address will be overwritten (erased and replaced by the new data). For information on how to check existing data, see the section “Recalling stored data” on page 90.

10. Start a measurement. When it finishes, a confirmation screen will be displayed. Select “Store data” and press the MENU/ENTER key to store the processing results.

The store process takes about 1 second. When it is completed, the address is incremented by one step. The stored data includes the following information: date and time when processing was started, measurement time, frequency weighting, time weighting (dynamic characteristics), conditions and processing results, overload and under-range information, other information.

The T-L (time-level graph) display screen is not stored.

Important

Any measurement data present in the currently displayed address will be overwritten. If the address is shown in red, it contains data. Take care not to accidentally overwrite data.
--

Note

When the number of address for storing data is 1000, it will not be incremented and it flashes on the display.
--

If you change the address with the \triangle or ∇ key in this condition, the flashing will stop, and data can be stored in the newly selected address.

Recalling stored data

The procedure for recalling data stored in memory using Manual mode is described below.

1. Press the MENU/ENTER key to bring up the menu list screen.
2. Use the $\triangle/\nabla/\leftarrow/\rightarrow$ keys to select [Recall] and press the MENU/ENTER key. The file selection screen appears.
3. Use the \triangle/∇ keys to select the data you want to recall and press the MENU/ENTER key.
4. Use the \triangle/∇ keys to select [Confirm the data] and press the MENU/ENTER key. The data stored in memory are displayed.

Deleting stored data

The procedure for deleting data stored in memory using Manual mode is described below.

Note
Data are deleted in store name units. It is not possible to selectively delete data for a specific address.

1. Press the MENU/ENTER key to bring up the menu list screen.
2. Use the $\Delta/\nabla/\triangleleft/\triangleright$ keys to select [Recall] and press the MENU/ENTER key. The file selection screen appears.
3. Use the Δ/∇ keys to select the data you want to delete and press the MENU/ENTER key.
4. Use the Δ/∇ keys to select [Delete the data] and press the MENU/ENTER key.
5. The confirmation screen appears. Select [Yes] and press the MENU/ENTER key. The selected data are deleted.

Copying stored data in internal memory to SD memory card

The procedure for copying stored data in internal memory to SD memory card is described below.

1. Press the MENU/ENTER key to bring up the menu list screen.
2. Use the $\Delta/\nabla/\triangleleft/\triangleright$ keys to select [Recall] and press the MENU/ENTER key. The file selection screen appears.
3. Use the Δ/∇ keys to select the internal memory data you want to copy to SD memory card and press the MENU/ENTER key.
4. Select [Copy to the card] and press the MENU/ENTER key.
5. The [Store name at copy dest.] screen appears. Use the $\Delta/\nabla/\triangleleft/\triangleright$ keys to set the store name and press the MENU/ENTER key.

Auto mode operation

Memory store

The optional Extended Function Program NX-42EX should be installed.

An SD memory card should be inserted.

With the Auto mode, L_p store and L_{eq} store are executed simultaneously (separate operation also possible).

The procedure for storing data using Auto mode is as follows.

Confirm the SD memory card has been inserted in the card slot.

1. Press the POWER key to turn the unit on.
2. Press the MENU/ENTER key to bring up the menu list screen.
3. Use the $\Delta/\nabla/\triangleleft/\triangleright$ keys to select [Store] and press the MENU/ENTER key. The store screen appears.
4. Use the Δ/∇ keys to select [Store Mode] and press the MENU/ENTER key. The store mode settings screen appears.
5. Use the Δ/∇ keys to select [Auto] and press the MENU/ENTER key.

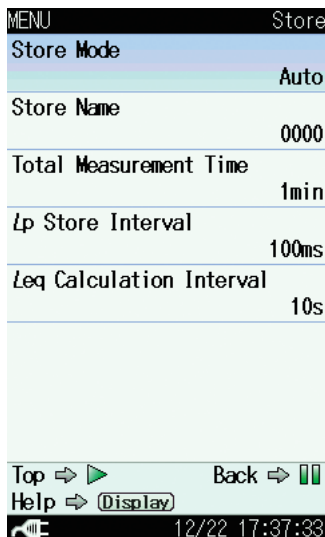

Store screen when Auto mode is selected

6. Specify the store name.
 - 6-1. Use the Δ/∇ keys to select [Store name] and press the MENU/ENTER key. The store name screen appears.
 - 6-2. Use the $\triangleleft/\triangleright$ keys to select the first two digits, and use the Δ/∇ keys to set the value.
 - 6-3. Use the $\triangleleft/\triangleright$ keys to select the final two digits, and use the Δ/∇ keys to set the value. Then press the MENU/ENTER key.
7. Set the total measurement time.
 - 7-1. Use the Δ/∇ keys to select [Total Measurement Time] and press the MENU/ENTER key. The total measurement time screen appears.
 - 7-2. Use the Δ/∇ keys to select the total measurement time (10s, 1min, 5min, 10min, 15min, 30min, 1h, 8h, 24h, Manual) and press the MENU/ENTER key.
 - 7-3. When “Manual” is selected, [User setting] is displayed on the store screen. Select [User setting] and press the MENU/ENTER key.
 - 7-4. The total measurement time setting screen appears. Set arbitrary total measurement time (At most for 1,000 hours).
8. Set the L_p store interval.
 - 8-1. Use the Δ/∇ keys to select [Lp Store Interval] and press the MENU/ENTER key. The L_p store interval screen appears.
 - 8-2. Use the Δ/∇ keys to select the L_p store interval (OFF, 100ms, 200ms, 1s, [Leq, 1s]) and press the MENU/ENTER key.
If the L_p store interval set to OFF, L_p is not stored.
 L_p , L_{eq} , L_{max} , L_{min} are stored when [100ms] is selected. In other cases, only L_p (L_{eq} when [Leq, 1s] is selected) is saved.
9. Set the L_{eq} calculation interval.
 - 9-1. Use the Δ/∇ keys to select [Leq Calculation Interval] and press the MENU/ENTER key. The L_{eq} calculation interval screen appears.

9-2. Use the Δ/∇ keys to select the L_{eq} calculation interval (OFF, 10s, 1min, 5min, 10min, 15min, 30min, 1h, 8h, 24h, Manual) and press the MENU/ENTER key.

If the L_{eq} calculation interval set to OFF, L_{eq} is not stored.

9-3. When “Manual” is selected, [User setting] is displayed on the store screen. Select [User setting] and press the MENU/ENTER key.

9-4. The L_{eq} calculation interval setting screen appears. Set arbitrary interval (At most for 24 hours).

Note
Both L_p store interval and L_{eq} calculation interval cannot be set to OFF.

10. Press the START/STOP key to return to the measurement screen.

11. Press the START/STOP key to start measurement. The measurement value will be stored automatically at every interval set for L_p store interval and L_{eq} calculation interval.

When it is completed, the address is incremented by one step.

Measurement will stop when the end of the total measurement time is reached.

To stop the process earlier, press the START/STOP key.

Note
Relationship between elapsed measurement time and number of data
When using Auto mode and 100-ms sampling, 10 data sets are stored per second. Therefore, when 10 seconds of measurement time have elapsed, the number of stored data is 100 (10 when using 1-second sampling).
During Auto mode, the pause function cannot be used.
During Auto mode, the address indication is based on number of L_{eq} calculation. The number of L_{eq} calculation is not displayed when L_{eq} calculation interval is OFF.

Marker

When the store mode is set to Auto or Timer Auto, and the L_p store interval is specified, a marker can be added to the data.

1. Select [Store] from the menu list screen and set the store mode to Auto or Timer Auto.
Also set the required measurement parameters such as L_p store interval.
2. Press the START/STOP key to set the unit to the measurement condition.
3. The \triangle (marker 1) and ∇ (marker 2) keys now function as markers. Pressing a key will insert the corresponding marker into the screen.
4. Wait until the preset measurement time has ended, or stop the measurement with the START/STOP key.
5. Select the [Recall] on the menu list screen and press the MENU/ENTER key.
6. Select data file and press the MENU/ENTER key. The file processing screen appears.
7. Select [Confirm the data] and press the MENU/ENTER key. The recall data is displayed.
8. Press the DISPLAY key to switch the display. A time-level screen appears showing the marker information.

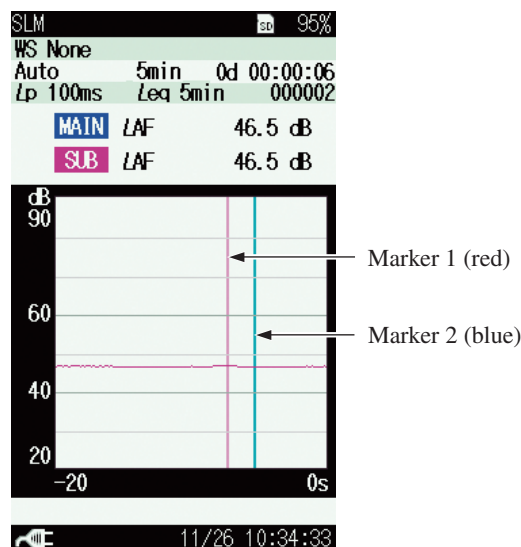

Time-Level screen

Recalling stored data

The procedure for recalling data stored in memory using Auto mode is described below.

1. Press the MENU/ENTER key to bring up the menu list screen.
2. Use the $\triangle/\nabla/\triangleleft/\triangleright$ keys to select [Recall] and press the MENU/ENTER key. The file selection screen appears.
3. Use the \triangle/∇ keys to select the data you want to recall and press the MENU/ENTER key.
4. Use the \triangle/∇ keys to select [Confirm the data] and press the MENU/ENTER key. The data stored in memory are displayed.

Deleting stored data

The procedure for deleting data stored in memory using Auto mode is described below.

1. Press the MENU/ENTER key to bring up the menu list screen.
2. Use the $\triangle/\nabla/\triangleleft/\triangleright$ keys to select [Recall] and press the MENU/ENTER key. The file selection screen appears.
3. Use the \triangle/∇ keys to select the data you want to delete and press the MENU/ENTER key.
4. Use the \triangle/∇ keys to select [Delete the data] and press the MENU/ENTER key.
5. The confirmation screen appears. Select [Yes] and press the MENU/ENTER key. The selected data are deleted.

Timer Auto mode operation

Memory store

The optional Extended Function Program NX-42EX should be installed.

An SD memory card should be inserted.

With the Timer Auto mode, L_p store and L_{eq} store are executed simultaneously (separate operation also possible).

The procedure for storing data using Timer Auto mode is as follows.

Confirm the SD memory card has been inserted in the card slot.

1. Press the POWER key to turn the unit on.
2. Press the MENU/ENTER key to bring up the menu list screen.
3. Use the $\Delta/\nabla/\triangleleft/\triangleright$ keys to select [Store] and press the MENU/ENTER key. The store screen appears.
4. Use the Δ/∇ keys to select [Store Mode] and press the MENU/ENTER key. The store mode settings screen appears.
5. Use the Δ/∇ keys to select [Timer Auto] and press the MENU/ENTER key.

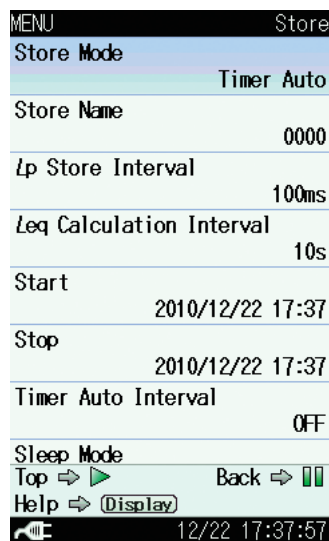

Store screen when Timer Auto mode is selected

6. Specify the store name.
 - 6-1. Use the \triangle/∇ keys to select [Store Name] and press the MENU/ENTER key. The store name screen appears.
 - 6-2. Use the $\triangleleft/\triangleright$ keys to select the first two digits, and use the \triangle/∇ keys to set the value.
 - 6-3. Use the $\triangleleft/\triangleright$ keys to select the final two digits, and use the \triangle/∇ keys to set the value. Then press the MENU/ENTER key.
7. Set the L_p store interval.
 - 7-1. Use the \triangle/∇ keys to select [Lp Store Interval] and press the MENU/ENTER key. The L_p store interval screen appears.
 - 7-2. Use the \triangle/∇ keys to select the L_p store interval (OFF, 100ms, 200ms, 1s, [Leq, 1s]) and press the MENU/ENTER key.
If the L_p store interval set to OFF, L_p is not stored.
 $L_p, L_{eq}, L_{max}, L_{min}$ are stored when [100ms] is selected. In other cases, only L_p (L_{eq} when [Leq, 1s] is selected) is saved.
8. Set the L_{eq} calculation interval.
 - 8-1. Use the \triangle/∇ keys to select [Leq Calculation Interval] and press the MENU/ENTER key. The L_{eq} calculation interval screen appears.
 - 8-2. Use the \triangle/∇ keys to select the L_{eq} calculation interval (OFF, 10s, 1min, 5min, 10min, 15min, 30min, 1h, 8h, 24h, Manual) and press the MENU/ENTER key.
If the L_{eq} calculation interval set to OFF, L_{eq} is not stored.
 - 8-3. When “Manual” is selected, [User setting] is displayed on the store screen. Select [User setting] and Press the MENU/ENTER key.
 - 8-4. The L_{eq} calculation interval setting screen appears. Set arbitrary interval (At most for 24 hours).

Note

Both L_p store interval and L_{eq} calculation interval cannot be set to OFF.

9. Set the start time. The measurement is started at the preset start time.
 - 9-1. Use the Δ/∇ keys to select [Start] and press the MENU/ENTER key. The start time setting screen appears. When the start time setting screen is displayed for the first time, current time is indicated.
 - 9-2. Use the $\triangleleft/\triangleright$ keys to select the setting parameter (year, month, day, hour, minute), and use the Δ/∇ keys to set the value.
 - 9-3. Repeat the step 9-2. When all the settings are completed, press the MENU/ENTER key.
10. Set the stop time. The measurement is stopped at the preset stop time.
 - 10-1. Use the Δ/∇ keys to select [Stop] and press the MENU/ENTER key. The stop time setting screen appears.
 - 10-2. Use the $\triangleleft/\triangleright$ keys to select the setting parameter (year, month, day, hour, minute), and use the Δ/∇ keys to set the value.
 - 10-3. Repeat the step 10-2. When all the settings are completed, press the MENU/ENTER key.
11. Set the timer auto interval. The “timer auto interval” is the time between measurements.
 - 11-1. Use the Δ/∇ keys to select [Timer Auto Interval] and press the MENU/ENTER key. The timer auto interval screen appears.
 - 11-2. Use the Δ/∇ keys to select the timer auto interval (OFF, 5min, 10min, 15min, 30min, 1h, 8h, 24h) and press the MENU/ENTER key.

When timer auto interval is set

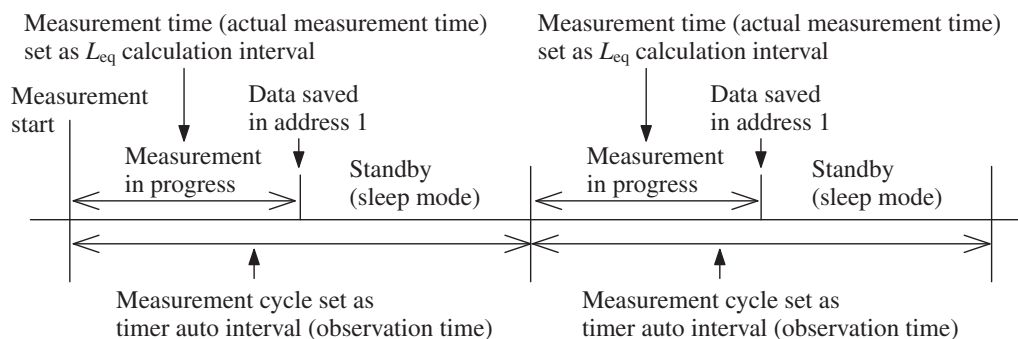

Note

When setting measurement parameters, the measurement time (actual measurement time) set with the L_{eq} calculation interval parameter may not exceed the measurement cycle (observation time) set with the timer auto interval parameter. Otherwise an error message will appear at the start of the measurement. If the measurement start time and end time are set to the same setting, measurement will not be performed.

12. Set the sleep mode (see page 61).
 - 12-1. Use the Δ/∇ keys to select [Sleep Mode] and press the MENU/ENTER key. The ON/OFF setting screen appears.
 - 12-2. When you use the sleep mode, select [ON] and press the MENU/ENTER key.
13. Press the START/STOP key. Measurement will start at the preset start time. The measurement value will be stored automatically at every interval set for L_p store interval and L_{eq} calculation interval. When it is completed, the address is incremented by one step. Measurement will stop at the preset stop time. To stop the process earlier, press the START/STOP key.

Note
Relationship between elapsed measurement time and number of data When using Timer Auto mode and 100-ms sampling, 10 data sets are stored per second. Therefore, when 10 seconds of measurement time have elapsed, the number of stored data is 100 (10 when using 1-second sampling).
During Timer Auto mode, the pause function cannot be used.
During Timer Auto mode, the address indication is based on number of L_{eq} calculation. The number of L_{eq} calculation is not displayed when L_{eq} calculation interval is OFF.

Marker

Same procedure as for Auto mode (see page 95).

Recalling stored data

Same procedure as for Auto mode (see page 96).

Deleting stored data

Same procedure as for Auto mode (see page 96).

Data size information

The maximum number of data sets that can be stored under one store name is 1000.

About the store data format

Data stored on the SD memory card are in CSV format. Various files and subdirectories are created on the card.

The store name specified on the menu screen is created as a 4-digit number under the subdirectory name.

The file of one per one address is made.

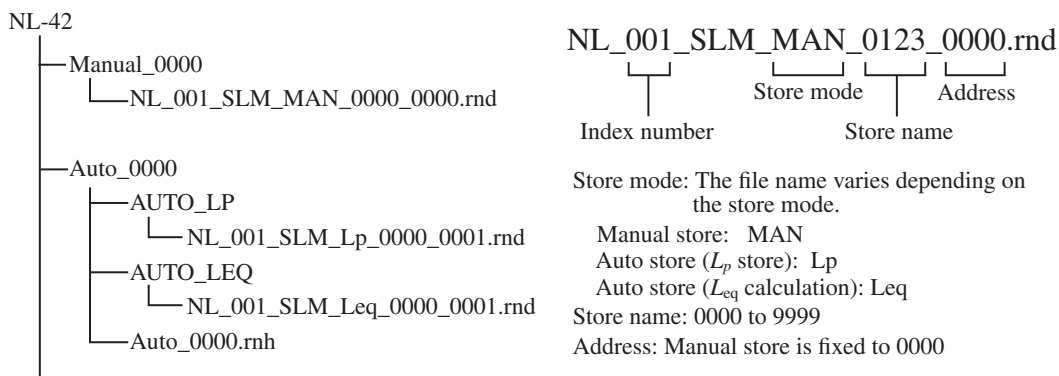

About SD memory cards

The memory cards that can be used in this unit are SD memory cards. Be sure to use optional SD memory cards provided by Rion. SD memory cards even from the same manufacturer and of the same type exhibit certain variations in specifications which may cause problems. For this reason, be sure to use only the SD memory cards provided by Rion. The performance of other cards is not guaranteed.

An SD memory card inserted in the unit will be recognized as a removable disk by the computer when connected via USB, without having to install a USB driver.

To make the connection, use a generic USB cable (standard A male to mini B male connector). When not using the communication function, set the Communication Interface to OFF from the [I/O] screen. When USB communication is enabled, a message requesting installation of a USB driver for USB communication will appear when the unit is connected to a computer.

Note
When using spreadsheet software or other programs on a computer to retrieve data from SD memory cards, some programs may not be able to read the original file names from the card. In such a case, rename the file using the extension “txt” (for example “NL_001_SLM_MAN_0123_0000.txt”). For software that identifies files by the file name extension, set the software up for reading text files.
If measurement data in the SD memory card is moved to a computer and then moved back to NL-42/NL-52, the measurement date (time stamp) may be different from the actual date.

Formatting an SD memory card

Important
Never format optional program cards such as the NX-42EX and NX-42WR with SD memory card formatting software (such as SD Formatter, etc.). Otherwise the program data on the card will be erased and the respective functions can no longer be used. Restoration of the erased program is not warranted.

Note
When an SD memory card is formatted (initialized), all data present on the card will be lost.

In the following cases, you should format the SD memory card:

- When using the SD memory card in the NL-42/NL-52 for the first time
- When wishing to delete all data from the SD memory card

To format an SD memory card, proceed as follows.

1. Select [Card Format] on the [SYSTEM (Language)] screen and press the MENU/ENTER key.
2. The confirmation screen appears. Press the MENU/ENTER key.

Note
When formatting the SD memory card in a computer, select FAT or FAT32 as file system.

Screen hard copy

When you press the \triangleright key of $\triangle/\nabla/\triangleleft/\triangleright$ keys while holding down the DISPLAY key, the “Screenshot was saved to the card” message is displayed and the current screen contents will be saved as a bitmap file on the SD memory card.

Store target folder:	\Screenshot\
File name:	Time at which the file was stored
File name extension:	.BMP
Data capacity:	Approximately 300 KB per file

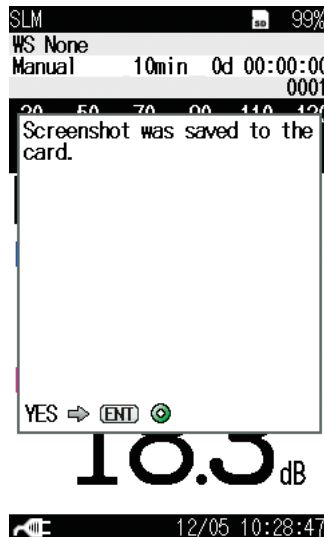

Input/Output Connectors

AC OUT connector

Set the frequency weighting characteristic of the signal output from the AC OUT connector of the unit.

1. Press the MENU/ENTER key to bring up the menu list screen.
2. Use the $\Delta/\nabla/\triangleleft/\triangleright$ keys to select [I/O] and press the MENU/ENTER key. The I/O screen appears.
3. Use the Δ/∇ keys to select [AC OUT] and press the MENU/ENTER key. The AC OUT setting screen appears.
4. Use the Δ/∇ keys to select the frequency weighting characteristic (OFF, Interlock, A, C, Z) and press the MENU/ENTER key.

When “Interlock” is selected, the main channel signal is output as AC signal weighted by the frequency set at a measurement.

When “A”, “C” or “Z” is selected, the main channel signal is output as AC signal weighted by the selected frequency.

Output voltage: 1 Vrms \pm 50 mVrms
(at Output Level Range Upper)

Example:

When the output level range upper is set to 120 dB, 1 Vrms \pm 50 mVrms is output at an input of 120 dB.

Output impedance: 600 Ω

Load impedance: 10 k Ω or more

Suitable cable: Output code CC-24 (BNC - mini plug cable)
The performance of other cables is not guaranteed.

If the “AC OUT” is set to OFF, the signal is not output.

Important

Using this feature will reduce battery life by about 25 percent.

The relationship between the display value shown by the unit and the output voltage is indicated below.

When the unit is set to the calibration mode, the output signal (output level range upper $120\text{ dB} - 6\text{ dB} = 114\text{ dB}$, 1000 Hz sinusoidal wave) is 0.5 Vrms .

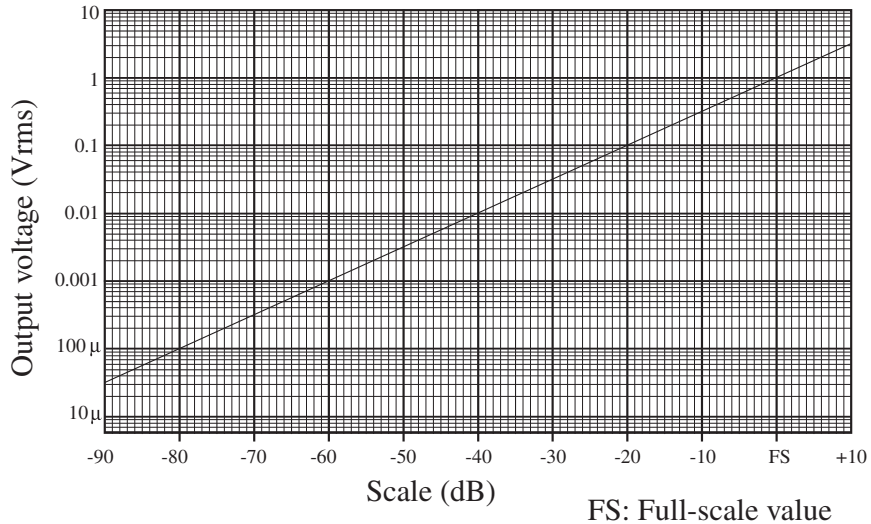

Ideal characteristics of the display value and the output voltage

Delay

The unit incorporates an A/D converter which converts the microphone input signal into digital format for processing by a DSP chip. The result is then returned to analog format by a D/A converter and output as an AC signal. Due to this process, the output signal has a constant delay time with regard to the microphone input signal. The delay time is about $700\text{ }\mu\text{s}$ in waveform recording, and about 1.3 ms in AC OUTPUT.

DC OUT connector

Set the frequency weighting characteristic of the signal output from the DC OUT connector of the unit.

1. Press the MENU/ENTER key to bring up the menu list screen.
2. Use the $\Delta/\nabla/\triangleleft/\triangleright$ keys to select [I/O] and press the MENU/ENTER key. The menu list screen appears.
3. Use the Δ/∇ keys to select [DC OUT] and press the MENU/ENTER key. The DC OUT setting screen appears.
4. Use the Δ/∇ keys to select [MAIN] and press the MENU/ENTER key.

The main channel signal is output to the DC OUT connector located at the bottom of the unit as a signal passing through the frequency weighting, rms detection and logarithmic compression processes. The signal is a level-converted DC signal having the frequency weighting and time weighting characteristics set by the unit.

Output voltage: 2.5 V, 25 mV/dB
(at Output Level Range Upper)

Example:

When the output level range upper is set to 120 dB, 2.5 V \pm 50 mV is output at an input of 120 dB.

Output impedance: 50 Ω

Load impedance: 10 k Ω or more

Suitable cable: Output code CC-24 (BNC - mini plug cable)
The performance of other cables is not guaranteed.

If the “DC OUT” is set to OFF, the signal is not output.

Important

Using this feature will reduce battery life by about 25 percent.

The relationship between the display value shown by the unit and the output voltage is indicated below.

When the unit is set to the calibration mode, the output signal (output level range upper $120 \text{ dB} - 6 \text{ dB} = 114 \text{ dB}$) is 2.35 V .

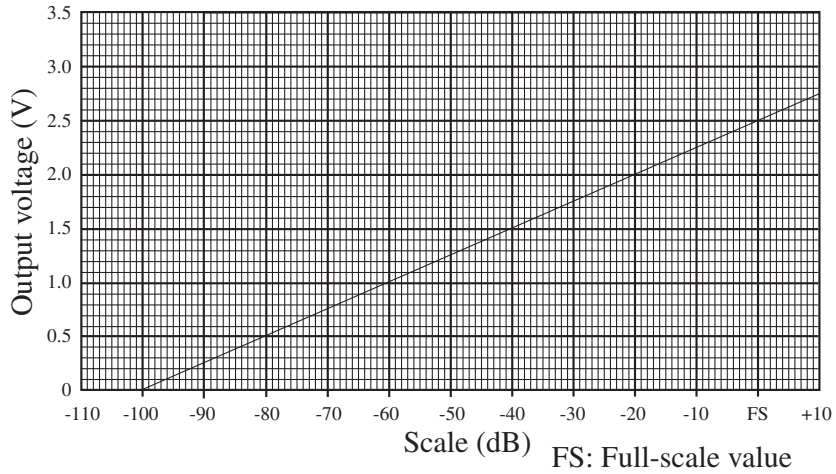

Ideal characteristics of the display value and the output voltage

I/O connector

The I/O connector is located at the bottom of the unit and used for RS-232C communication or comparator output.

To use this connector for RS-232C communication and connect to a printer, see page 22. For comparator output, see page 33.

Note

The RS-232C communication and the comparator output cannot be used at the same time.

Comparator output

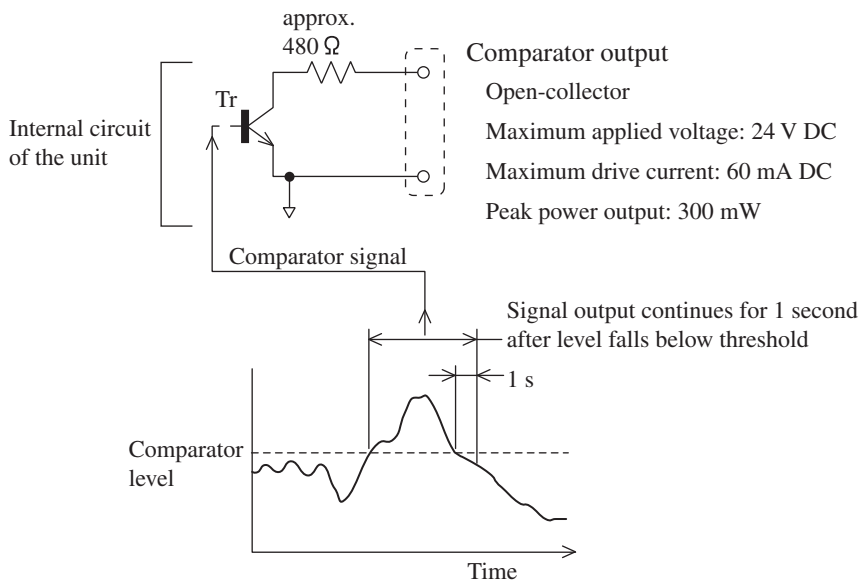

Default Settings

The factory default settings of the unit are listed below.

Main channel frequency weighting	A
Main channel time weighting	F(Fast)
Output level range upper	130 dB
Output level range lower	30 dB
Calibration mode	Internal
Back erase.....	OFF
Delay time	OFF
Windscreen correction	WS None
Diffuse sound field correction (DF)	OFF
Sub channel settings.....	OFF
Sub channel frequency weighting.....	A
Sub channel time weighting	F(Fast)
LN Mode	Lp
L_{eq}	ON
L_E	OFF
L_{max}	ON
L_{min}	OFF
L_{N1} (L05)	OFF
L_{N2} (L10).....	OFF
L_{N3} (L50)	ON
L_{N4} (L90)	OFF
L_{N5} (L95)	OFF
Time-Level	ON
Time scale.....	20 s
Setting the additional processings	OFF
Store mode.....	Manual
Store name	0000
Measurement time	10 min
Eco setting.....	OFF
AC OUT	Inter lock
DC OUT	MAIN

Comparator (NX-42EX).....	OFF
Communication interface.....	OFF
Baud rate.....	9600 bps
Backlight auto off	30 s
Backlight brightness	2
LCD auto off at auto store.....	OFF
Index.....	1
Battery type	Alkaline
Touch panel lock.....	OFF

When you turn power to the unit on while holding down the START/STOP key, the unit will be initialized to the above settings. When wishing to set the unit to the factory default values, select [menu] → [system – Read/Save Setting] → [Load Default Settings] and then press the MENU/ENTER key (see page 114). The time, language and store data are not initialized.

Setup Files

Resume function

When power to the unit is turned on, the measurement screen appears. The settings active at this point are the same as were selected before the unit was last turned off (resume function).

Note

When the unit is started while a start up file exists in the internal memory and SD memory card, the start up file load function (see the following description) will be executed first.

Loading a start up file at startup

If a start up file exists both in the internal memory of the unit and on the inserted SD memory card, a selection screen such as shown at bottom left will appear. Select [Internal Memory] or [SD] to load the respective startup file. Selecting [Cancel] at the screen will cause the resume function to re-establish the same settings as before the last time the unit was turned off. If a startup file exists either in the internal memory of the unit or on the inserted SD memory card, a selection screen such as shown at bottom right will appear. (The example is for a startup file in the internal memory.)

Selecting [Yes] at the screen will load the start up file.

Selecting [No] at the screen will cause the resume function to re-establish the same settings as before the last time the unit was turned off.

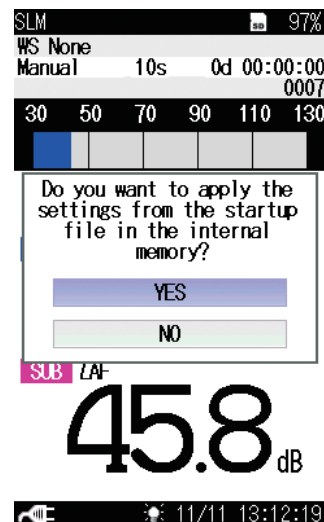
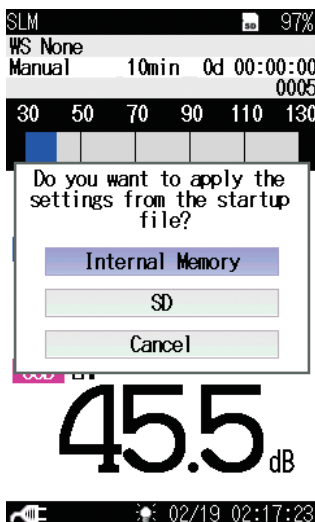

Restoring default settings (factory default settings)

Follow the steps below to restore the default settings.

1. Use the $\Delta/\nabla/\triangleleft/\triangleright$ keys to select [System (Language)] and press the MENU/ENTER key. The system screen appears.
2. Use the Δ/∇ keys to select [Read/Save setting] and press the MENU/ENTER key. The setting operation screen appears.
3. Use the Δ/∇ keys to select [Load Default Settings] and press the MENU/ENTER key. The confirmation screen appears.
4. Use the Δ/∇ keys to select [Yes] and press the MENU/ENTER key.

For information on items that will be default, see the “Default Settings” section on page 111.



Setting operation screen

Using setup files

Setup files enable the following functions.

- Establish settings quickly and precisely by loading from a file prepared beforehand and stored on internal memory or SD memory card
- Return settings that were accidentally changed to the previous condition by loading from a file stored on internal memory or SD memory card

Setup files can be saved up to five in the internal memory of the unit and up to five in an SD memory card.

Saving the current settings

1. Use the $\Delta/\nabla/\triangleleft/\triangleright$ keys to select [System (Language)] and press the MENU/ENTER key. The system screen appears.
2. Use the Δ/∇ keys to select [Read/Save setting] and press the MENU/ENTER key. The setting operation screen appears.
3. Use the Δ/∇ keys to select the desired number and press the MENU/ENTER key. The setting file processing screen appears.
4. Use the Δ/∇ keys to select [Save the setting] and press the MENU/ENTER key. The confirmation screen appears.
5. Use the Δ/∇ keys to select [Yes] and press the MENU/ENTER key. The current settings is saved in the selected number.



Note

The recall screen settings are not saved. Only the settings of the immediately preceding measurement screen will be saved.

Loading a setup file

Note
When you load settings from a file, the current settings will be overwritten. If necessary, you should save the current settings before loading a new set of settings.

1. Use the $\Delta/\nabla/\triangleleft/\triangleright$ keys to select [System (Language)] and press the MENU/ENTER key. The system screen appears.
2. Use the Δ/∇ keys to select [Read/Save setting] and press the MENU/ENTER key. The setting operation screen appears.
3. Use the Δ/∇ keys to select the desired number and press the MENU/ENTER key. The setting file processing screen appears.
4. Use the Δ/∇ keys to select [Load the setting] and press the MENU/ENTER key. The confirmation screen appears.
5. Use the Δ/∇ keys to select [Yes] and press the MENU/ENTER key. The file contents of the selected number will be reflected to the setting of the unit.

Deleting a setup file

1. Use the $\Delta/\nabla/\triangleleft/\triangleright$ keys to select [System (Language)] and press the MENU/ENTER key. The system screen appears.
2. Use the Δ/∇ keys to select [Read/Save setting] and press the MENU/ENTER key. The setting operation screen appears.
3. Use the Δ/∇ keys to select the desired number and press the MENU/ENTER key. The setting file processing screen appears.
4. Use the Δ/∇ keys to select [Delete] and press the MENU/ENTER key. The confirmation screen appears.
5. Use the Δ/∇ keys to select [Yes] and press the MENU/ENTER key. The file of selected number is deleted.

Copying a setup file

1. Use the $\Delta/\nabla/\triangleleft/\triangleright$ keys to select [System (Language)] and press the MENU/ENTER key. The system screen appears.
2. Use the Δ/∇ keys to select [Read/Save setting] and press the MENU/ENTER key. The setting operation screen appears.
3. Use the Δ/∇ keys to select the desired number and press the MENU/ENTER key. The setting file processing screen appears.
4. Use the Δ/∇ keys to select [Copy] and press the MENU/ENTER key.
5. Select a destination on the screen using the Δ/∇ keys and then press the MENU/ENTER key. The confirmation screen appears.
6. Use the Δ/∇ keys to select [Yes] and press the MENU/ENTER key. The file of selected number is copied.

Setting a start up file

When a setting is saved in a start up file, the unit can be started using the setting.

1. Set the unit to the intended condition, so that measurement parameters and other settings are as desired.
2. Use the $\Delta/\nabla/\triangleleft/\triangleright$ keys to select [System (Language)] and press the MENU/ENTER key. The system screen appears.
3. Use the Δ/∇ keys to select [Read/Save setting] and press the MENU/ENTER key. The setting operation screen appears.
4. Use the Δ/∇ keys to select [Startup File None] of [Internal Memory] or [SD] and press the MENU/ENTER key. The [Save the setting]/[Cancel] selecting screen appears.

Note

When a start up file has already been saved, select [Startup File Data is available]

5. Use the Δ/∇ keys to select [Save the setting] and press the MENU/ENTER key. When “The setting was saved” is displayed, it means that the saving process has been completed.

Note

When selecting [Startup File Data is available] to overwrite the data, select [Yes] on the confirmation screen.

MENU Setting operation

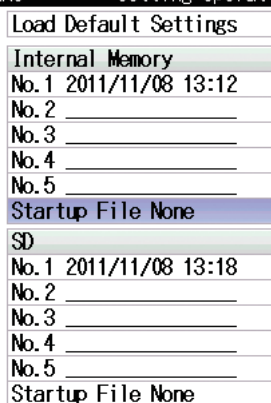

MENU Setting operation

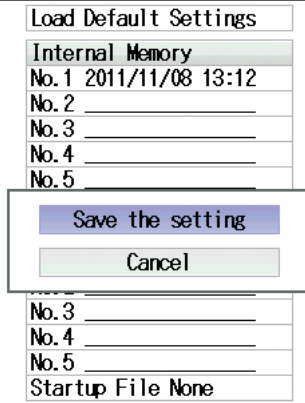

Optional Accessories

Microphone extension cables (EC-04 series)

For enhanced measurement accuracy, the microphone can be detached from the unit and connected via an extension cable. This will reduce measurement deviations due to refraction effects of the unit or the acoustic influence of the operator.

Six different cable types with lengths from 2 to 100 meters are available, as listed in the table below. It is also possible to combine multiple cables.

Important

With long extension cables, the cable capacitance restricts the upper measurement frequency and measurement level. For details, refer to the Technical Notes.

Type	Length
EC-04	2 m
EC-04A	5 m
EC-04B	10 m

Type	Length
EC-04C	30 m (reel) + 5 m (connection cable)
EC-04D	50 m (reel) + 5 m (connection cable)
EC-04E	100 m (reel) + 5 m (connection cable)

Printer DPU-414

Data stored in the memory of the unit and on SD memory card can be printed out on a printer. You can also produce hard copy of measurement screens. (The printer, printer paper, and printer cable are options.)

To print measurement data, turn the unit and the printer on and set the printer to the online state. The steps described in the chapter “Preparations” (page 10) should be completed.

For details about printer operation, refer to the documentation supplied with the printer.

Printing a measurement screen

The steps for printing hard copy of a measurement screen are described below.

1. Press the MENU/ENTER key to bring up the menu list screen.
2. Use the $\Delta/\nabla/\triangleleft/\triangleright$ keys to select [Save/Print] and press the MENU/ENTER key. The save/print screen appears.
3. Use the Δ/∇ keys to select [Print] and press the MENU/ENTER key. The screen is printed.

To cancel the process, select [Cancel] and press the MENU/ENTER key.

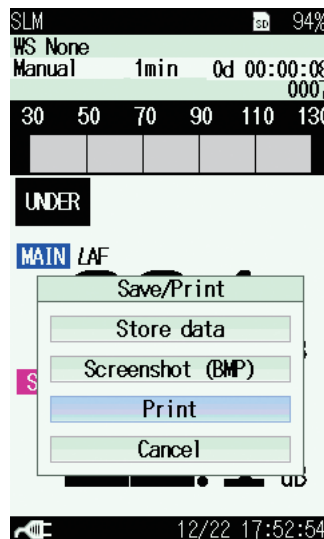

Printing stored data

The steps for printing hard copy of a stored data are described below.

1. Press the MENU/ENTER key to bring up the menu list screen.
2. Use the $\Delta/\nabla/\triangleleft/\triangleright$ keys to select [Recall] and press the MENU/ENTER key. The recall screen appears.
3. Use the $\Delta/\nabla/\triangleleft/\triangleright$ keys to select the desired data and press the MENU/ENTER key. The data processing screen appears.
4. Use the Δ/∇ keys to select [Confirm the data] and press the MENU/ENTER key. The stored data screen appears.

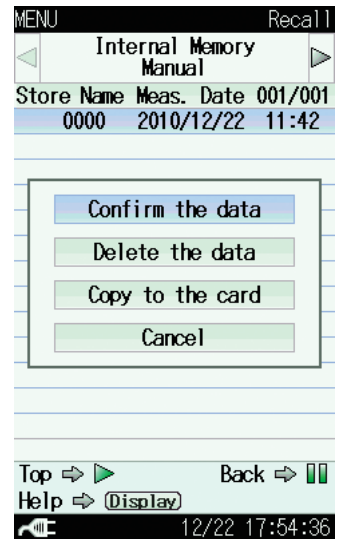

5. When the stored data screen is displayed, pressing the MENU/ENTER key brings up the menu list screen for stored data.

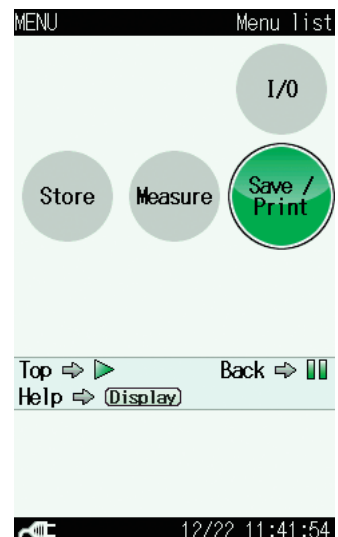

6. Use the Δ / ∇ / \triangleleft / \triangleright keys to select [Save/Print] and press the MENU/ENTER key. The save/print screen appears.
7. Use the Δ / ∇ keys to select [Range Setting Print] and press the MENU/ENTER key. The range setting print screen appears.
8. Set the [Start Addr.] and [End Addr.] and then select [Print Execution] and press the ENTER key. The data within the area specified by the entered addresses will be printed

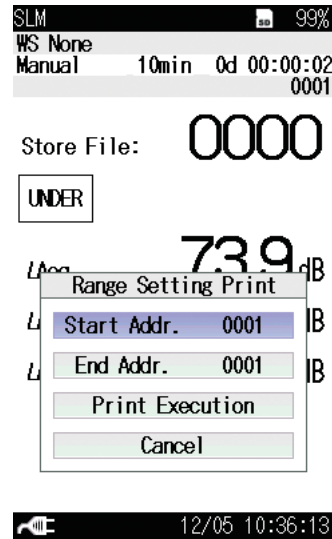
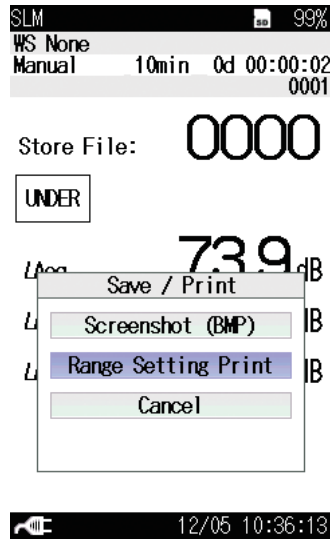

Level recorder LR-07/LR-20A

By connecting a level recorder to the unit, the sound level changes over time can be recorded.

Sound level recording

The procedure for recording sound level changes over time is described below. Turn power to the NL-42/NL-52 and the level recorder on. The steps described in the chapter “Preparations” (page 10) should be completed. For details about level recorder operation, refer to the documentation supplied with the level recorder.

1. To select the AC signal output to the recorder, press the MENU/ENTER key to bring up the menu list screen.
2. Use the $\Delta/\nabla/\triangleleft/\triangleright$ keys to select [I/O] and press the MENU/ENTER key. The I/O screen appears.
3. Use the Δ/∇ keys to select [AC OUT] and press the MENU/ENTER key. The AC OUT setting screen appears.
4. Use the Δ/∇ keys to select the frequency weighting characteristic (Interlock, A, C, Z) and press the MENU/ENTER key.
5. Press the START/STOP key to return to the measurement screen.
6. To adjust the level of the recorder, press the CAL key to set the unit to the internal calibration mode.
7. Adjust the level control (Level adj) of the level recorder so that the pen registers at -6 dB from the top of the scale.

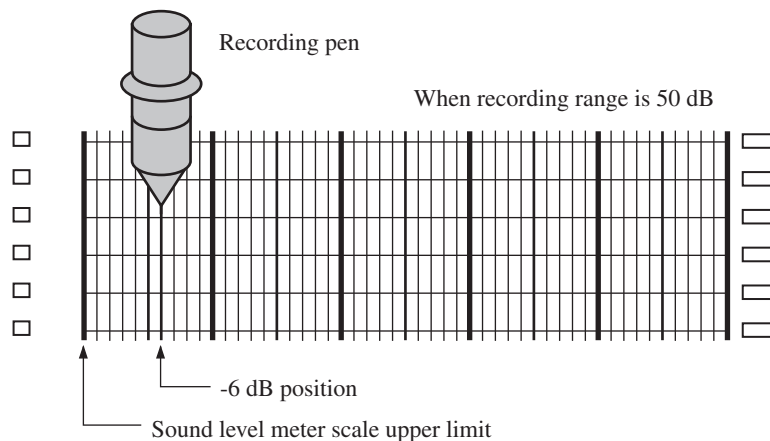

8. Press the CAL key once more to return the NL-42/NL-52 to the measurement mode.
9. Set the time weighting characteristic at the level recorder.
10. Set the [Output Level Range Upper] and [Output Level Range Lower] on the [Display] screen.
The [Output Level Range Upper] setting of the NL-42/NL-52 becomes the scale upper limit of the level recorder.

Program options

The unit can make use of a range of program options.

For details on usage, refer to the documentation supplied with the respective program.

Note
Once the Extended Function Program NX-42EX has been installed, it can no longer be uninstalled.

Specifications

Applicable standards

NL-42	IEC 61672-1:2013/2002 class 2 ANSI/ASA S1.4-2014/Part 1 class 2 JIS C 1509-1:2017 class 2 JIS C 1516:2014 class 2
NL-52	IEC 61672-1:2013/2002 class 1 ANSI/ASA S1.4-2014/Part 1 class 1 JIS C 1509-1:2017 class 1 JIS C 1516:2014 class 1
NL-42/NL-52	CE marking WEEE Directive, China RoHS

Measurement function Simultaneous measurement of all items, using selected time weighting and frequency weighting

Main processing (Main channel)

Instantaneous sound pressure level	L_p
Equivalent continuous sound pressure level	L_{eq}
Sound exposure level	L_E
Maximum sound pressure level	L_{max}
Minimum sound pressure level	L_{min}
Percentile sound level	$L_{N1}, L_{N2}, L_{N3}, L_{N4}$ (1 to 99, 1-increment steps)
	L_{N5} (0.1 to 99.9, 0.1-increment steps)

Main processing (Sub channel)

Instantaneous sound pressure level	L_p
------------------------------------	-------

Additional processing

One of the following measurements can also be selected for simultaneous processing with main processing.

C-weighted equivalent continuous sound level

$$L_{Ceq}$$

C-weighted peak sound level

$$L_{Cpeak}$$

Z-weighted peak sound level

$$L_{Zpeak}$$

I-time-weighted equivalent continuous sound level

$$L_{A1eq}$$

Tact-max A-weighted sound level

$$L_{Atm5}$$

Maximum I-time-weighted equivalent continuous sound level

$$L_{AImax}$$

NX-42EX is required in order to measure L_{A1eq} and L_{AImax} .

The frequency weighting of additional processing is associated with the frequency weighting of the sub channel.

Therefore, L_{A1eq} or L_{AImax} can be selected when the sub channel has A weighting.

L_{Ceq} or L_{Cpeak} can be selected when the sub channel has C weighting, L_{Zpeak} can be selected when the sub channel has Z weighting.

Processing period

The processing period can be selected from 10 sec, 1 min, 5 min, 10 min, 15 min, 30 min, 1 h, 8 h, 24 h and manually selected arbitrary time.

Arbitrary period of time up to 24 h can be set manually. When Auto store mode is selected, up to 1000 hours can be set.

Microphone

	NL-42	NL-52
Model:	UC-52	UC-59
Sensitivity:	-33 dB	-27 dB

Preamplifier

	NL-42	NL-52
Model:	NH-24	NH-25

Measurement range	A-weighting:	25 dB to 138 dB
	C-weighting:	33 dB to 138 dB
	Z-weighting:	38 dB to 138 dB
	C-weighted peak sound level:	55 dB to 141 dB
	Z-weighting peak sound level:	60 dB to 141 dB
Inherent Noise		NL-42 NL-52
	A-weighting:	19 dB or less 17 dB or less (Typ. 16 dB) (Typ. 14 dB)
	C-weighting:	27 dB or less 25 dB or less
	Z-weighting:	32 dB or less 30 dB or less
Total range	25 dB to 138 dB (A weighting, 1 kHz)	
Linear operating range	All-pass (A-weighting)	113 dB
	Measurement frequency range	
	20 Hz to 8 kHz (NL-42)	
	10 Hz to 20 kHz (NL-52)	
Reference frequency	1 kHz	
Reference sound pressure level	94 dB	
	Frequency weighting	A, C, Z
Time weighting	F (Fast), S (Slow)	
Bar graph display range	Max. 110 dB (20 to 130 dB)	
	Bar graph range switch	Upper and lower limits of the bar graph can be set in increments of 10 dB.
Display full scale	Upper limit of bar graph display	
RMS detection circuit	Digital processing method	
	Sampling interval	$L_p, L_{eq}, L_E, L_{max}, L_{min}, L_{peak}$: 20.8 μ s (Sampling frequency: 48 kHz) L_N : 100 ms, $L_{eq, 1s}$

Calibration

Internal calibration

Electrical calibration with signal from built-in oscillator
(1 kHz, [scale upper limit of the bar graph] – 6 dB)

Acoustic calibration

NC-75/NC-74 (1 kHz, 93.9 dB [NL-42] / 94.0 dB [NL-52])

NC-72B/NC-72A (250 Hz, 114.0 dB)

Correction functions

Windscreen correction

Reduces influence of mounted windscreen on frequency response characteristics.

Turning on/off the correction function is done from the menu screen.

* The unit complies with IEC 61672-1, JIS C 1509-1, JIS C 1516 and ANSI/ASA S1.4 with windscreen mounted.

Diffuse sound field correction

Corrects frequency response to meet the standard (ANSI/ASA S1.4) in diffuse sound field.

Turning on/off the correction function is done from the menu screen.

Delay time

Sets a delay in starting measurement from the point of pressing the START/STOP key.

Setting range: The delay time is selected from OFF, 1, 3, 5 or 10 sec and set to it.

Previous data removal function (Back-erase function)

When measurement is paused with the PAUSE/CONT key, the data of some seconds from the point of pressing the PAUSE/CONT key are excluded from processing. During Auto store or when waveform recording function is set to ON, this function has no effect.

Setting range: The time is selected from OFF, 1, 3 or 5 sec and set to it.

Display	Backlit semitransparent color TFT LCD display WQVGA (400 × 240 dots) * LCD is equipped with the touch panel (capacitance type) control function.
Bar graph update frequency	100 ms
Numeric display update frequency	1 s
Manual store	Measurement result and measurement start time are stored on an address to address basis.
Measurement time	1 sec to 24 hours
Data store capacity	Up to 1000 data sets in the internal memory External memory depends on the SD memory card capacity (only the performance of Rion genuine cards is guaranteed).
Data recall	Allows viewing of store data.
Setup memory	Up to five setup configurations can be saved in the internal memory and SD memory card for later recalls. The unit can be started using the setting file stored in the internal memory and SD memory card beforehand.
Output	
DC output	The DC out connector outputs a DC signal weighted by frequency weighting and time weighting characteristics set by the unit. DC output: 2.5 V, 25 mV/dB at display full-scale point Output impedance: 50 Ω Load impedance: 10 kΩ minimum
AC output	The AC Out connector outputs an AC signal weighted by “Inter lock”, “A weighting”, “C weighting” or “Z weighting” which can be selected in the AC out settings. Output voltage: 1 Vrms (rms) at display full-scale point Output impedance: 600 Ω Load impedance: 10 kΩ minimum

DC/AC simultaneous output	Enables simultaneous output of DC output and AC output.
Overload Characteristics/Under-Range	<p>OVER is displayed when the input level is 138.3 dB or higher at all-pass level.</p> <p>OUTPUT OVER is displayed at +8.3 dB or higher above the indicated upper range when AC or DC output is available.</p> <p>UNDER is displayed at -0.5 dB or lower below the lower limit of the range.</p>
USB	
Mass storage class	Connected to a computer as a storage device, and recognized as a removable disk (USB connector is used).
Communication device class	Allows control with communication commands using communication device class. However, the settings related to store data transfer and store operation cannot be handled by communication commands.
Printout	Prints measurement results via the dedicated printer DPU-414 (I/O connector is used).
Screen print mode	Makes one copy of displayed screen.
Memory print mode	Makes continuous printing of data within the address range specified by memory.
BMP files	Screen capture data can be saved as BMP files.
RS-232C communication	Allows RS-232C communication using the dedicated cable (I/O connector is used).

Power requirements	Four AA batteries or external power supply		
Battery life (at 23°C):	Alkaline batteries LR6: Approx. 26 hours		
	Ni-MH secondary batteries: Approx. 25 hours		
	(Depending on the manufacturer)		
	Battery life varies depending on the setting of this unit.		
AC adapter	NC-98 series		
External DC power supply	5 V to 7 V (rated voltage 6 V)		
Current Consumption	90 mA (normal operation, rated voltage)		
Ambient conditions for use	-10°C to 50°C, 10% to 90% RH (no condensation)		
Water and dust resistant performance	IP 54 (except microphone unit)		
	Protection against harmful dust and water splashing from any direction.		
Dimensions	Approx. 250 mm (H) × 76 mm (W) × 33 mm (D)		
Weight	Approx. 400 g (including batteries)		
Supplied accessories			
Storage case	NL-42-025		1
Windscreen	WS-10		1
Windscreen fall prevention rubber	NL-42-033		1
Hand strap	VM-63-017		1
Size AA alkaline batteries	LR6		4
Instruction manuals (CD-ROM)			
(Instruction Manual, Serial Interface Manual, Technical Notes)			1
Description for IEC 61672-1			1
Inspection certificate			1

Optional accessories

SD Card 512 MB	MC-51SD1
SD Card 2 GB	MC-20SD2
SD Card 32 GB	MC-32SP3
AC adapter (100 V to 240 V)	NC-98 series
Battery pack	BP-21A
Microphone extension cable	EC-04 series
All-Weather Windscreen	WS-15
Mounting adapter for windscreen	WS15006
Rain-protection Windscreen	WS-16
BNC - Pin output code	CC-24/CC-24S
Comparator output cable	CC-42C
Printer	DPU-414
Printer cable	CC-42P
USB cable (A - mini B)	Commercially available
RS-232C serial I/O cable	CC-42R
Data management software for environmental measurement	AS-60
Data management software for environmental measurement (Includes the Octave and 1/3 Octave data management software)	AS-60RT
Waveform analysis software	AS-70 / CAT WAVE
Sound calibrator	NC-75
Pistonphone	NC-72B
Sound level meter tripod	ST-80
All-weather windscreen tripod	ST-81
Data recorder	DA-21
Level recorder	LR-07
Program option	
Extended Function Program	NX-42EX
Waveform Recording Program	NX-42WR
Octave • 1/3 Octave Real-time Analysis Program	NX-42RT
Reverberation Time Measurement Program	NX-42RV
FFT Analysis Program	NX-42FT

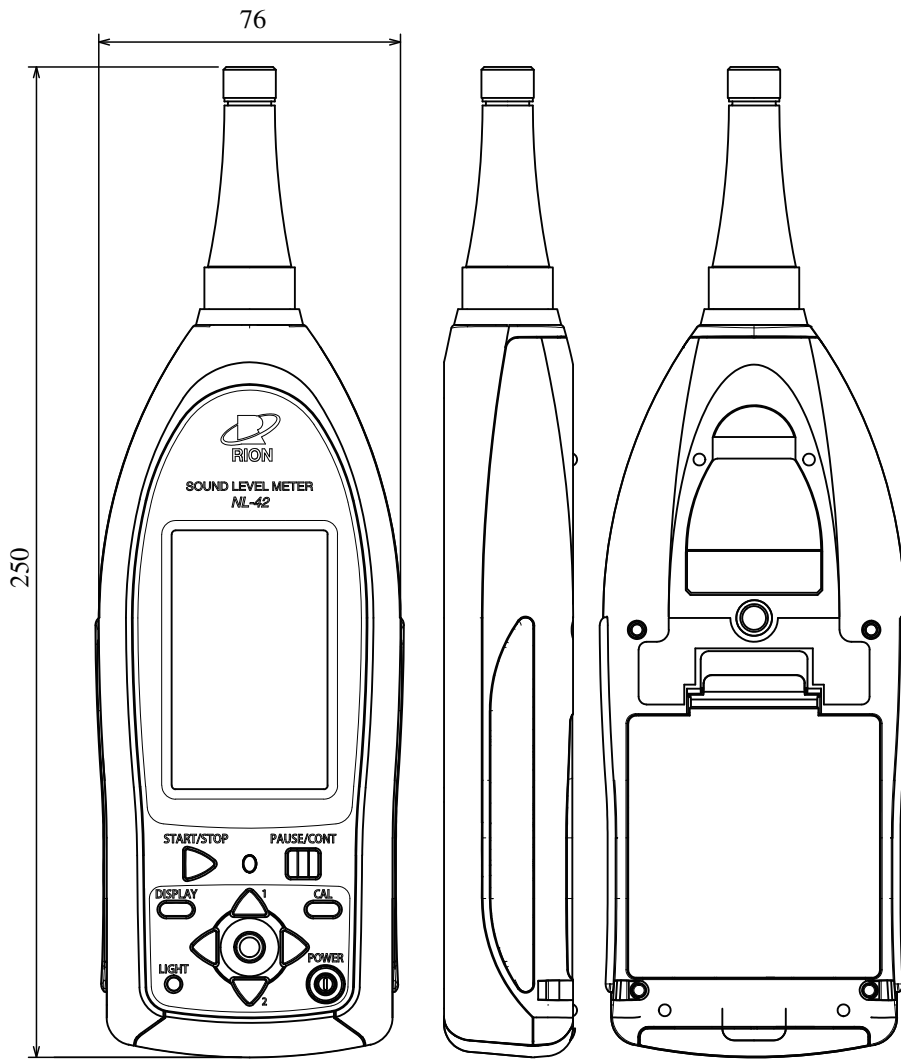

Front view

Side view

Rear view

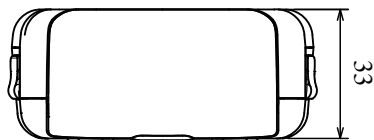

Bottom view

Unit: mm

Dimensional Drawings



This product is environment-friendly. It does not include toxic chemicals on our policy.